

# CUEPIX 16IP™

user manual

©2018 ELATION PROFESSIONAL all rights reserved. Information, specifications, diagrams, images, and instructions herein are subject to change without notice. ELATION PROFESSIONAL logo and identifying product names and numbers herein are trademarks of ELATION PROFESSIONAL. Copyright protection claimed includes all forms and matters of copyrightable materials and information now allowed by statutory or judicial law or hereinafter granted. Product names used in this document may be trademarks or registered trademarks of their respective companies and are hereby acknowledged. All non-ELATION brands and product names are trademarks or registered trademarks of their respective companies.

**ELATION PROFESSIONAL** and all affiliated companies hereby disclaim any and all liabilities for property, equipment, building, and electrical damages, injuries to any persons, and direct or indirect economic loss associated with the use or reliance of any information contained within this document, and/or as a result of the improper, unsafe, insufficient and negligent assembly, installation, rigging, and operation of this product.

**Elation Professional USA** | 6122 S. Eastern Ave. | Los Angeles, CA. 90040

323-582-3322 | 323-832-9142 fax | [www.elationlighting.com](http://www.elationlighting.com) | [info@elationlighting.com](mailto:info@elationlighting.com)

**Elation Professional B.V.** | Junostraat 2 | 6468 EW Kerkrade, The Netherlands

+31 45 546 85 66 | +31 45 546 85 96 fax | [www.elationlighting.eu](http://www.elationlighting.eu) | [info@elationlighting.eu](mailto:info@elationlighting.eu)

**Elation Professional Mexico** | AV Santa Ana 30 | Parque Industrial Lerma, Lerma, Mexico 52000

+52 (728) 282-7070

## DOCUMENT VERSION

**Due to additional product features and/or enhancements, an updated version of this document may be available online.**

**Please check [www.elationlighting.com](http://www.elationlighting.com) for the latest revision/update of this manual, before beginning installation and/or programming.**

Date	Document Version	Software Version $\geq$	DMX Channel Modes	Notes
06/05/18	1	1.04	14	Initial release.
06/19/18	1.2	N/C	NO CHANGE	Updated release.
06/20/18	1.4	N/C	NO CHANGE	Updated DMX traits.

# CONTENTS

General Information	4
Limited Warranty (USA Only)	5
Safety Guidelines	6
Maintenance Guidelines	8
Fixture Overview	9
Installation Guidelines	10
System Menu	16
Pixel Control	19
DMX Channel Functions and Values	20
Technical Specifications	34
Optional Accessories	37

# GENERAL INFORMATION

## INTRODUCTION

This fixture has been designed to perform reliably for years when the information in this manual are followed. Please read and understand all the instructions and guidelines carefully and thoroughly before operating this unit. This manual contains important information regarding safety, installation, use, and maintenance.

## UNPACKING

Each fixture has been thoroughly tested and shipped in perfect operating condition. Carefully check the outer shipping carton for signs of any damage that may have occurred during shipping. If the outer carton appears to be damaged, carefully inspect the fixture for damage and be sure all included accessories have arrived intact. In the event damage has been found and/or parts are missing, please contact our customer support team for further instructions. Please do NOT return this fixture to your dealer without first contacting customer support at the number listed below. Please do NOT discard the outer shipping carton in the trash. Please recycle whenever possible.

## CUSTOMER SUPPORT

Elation Professional provides a customer support line to provide set up help and answer any set up or operation questions. You may also visit us on the web at [www.elationlighting.com](http://www.elationlighting.com) for any comments or suggestions. For service related issue please contact Elation Professional.

### **ELATION SERVICE USA - Monday - Friday 8:00am to 5:00pm PST**

**Voice: 323-582-3322**

**Fax: 323-832-9142**

E-mail: [support@elationlighting.com](mailto:support@elationlighting.com)

### **ELATION SERVICE EUROPE - Monday - Friday 08:30 to 17:00 CET**

**Voice: +31 45 546 85 30**

**Fax: +31 45 546 85 96**

E-mail: [support@elationlighting.eu](mailto:support@elationlighting.eu)

## WARRANTY REGISTRATION / RETURNS

Please register online: <http://www.elationlighting.com/Login.aspx> to validate your purchase. All returned service items whether under warranty or not, must be freight pre-paid and accompany a return authorization (R.A.) number. The R.A. number must be clearly written on the outside of the return package. A brief description of the problem as well as the R.A. number must also be written down on a piece of paper and included in the shipping container. If the unit is under warranty, you must provide a copy of your proof of purchase invoice. Items returned without a R.A. number clearly marked on the outside of the package will be refused and returned at customer's expense. You may obtain a R.A. number by contacting customer support.

## **LIMITED WARRANTY (USA ONLY)**

A. Elation Professional hereby warrants, to the original purchaser, Elation Professional products to be free of manufacturing defects in material and workmanship for a period of two years (730 days), and Elation Professional product rechargeable batteries to be free of manufacturing defects in material and workmanship for a period of six months (180 days), from the original date of purchase. This warranty excludes discharge lamps and all product accessories. This warranty shall be valid only if the product is purchased within the United States of America, including possessions and territories. It is the owner's responsibility to establish the date and place of purchase by acceptable evidence, at the time service is sought.

B. For warranty service, send the product only to the Elation Professional factory. All shipping charges must be pre-paid. If the requested repairs or service (including parts replacement) are within the terms of this warranty, Elation Professional will pay return shipping charges only to a designated point within the United States. If any product is sent, it must be shipped in its original package and packaging material. No accessories should be shipped with the product. If any accessories are shipped with the product, Elation Professional shall have no liability what so ever for loss and/or or damage to any such accessories, nor for the safe return thereof.

C. This warranty is void if the product serial number and/or labels are altered or removed; if the product is modified in any manner which Elation Professional concludes, after inspection, affects the reliability of the product; if the product has been repaired or serviced by anyone other than the Elation Professional factory unless prior written authorization was issued to purchaser by Elation Professional; if the product is damaged because not properly maintained as set forth in the product instructions, guidelines and/or user manual.

D. This is not a service contract, and this warranty does not include any maintenance, cleaning or periodic check-up. During the periods as specified above, Elation Professional will replace defective parts at its expense, and will absorb all expenses for warranty service and repair labor by reason of defects in material or workmanship. The sole responsibility of Elation Professional under this warranty shall be limited to the repair of the product, or replacement thereof, including parts, at the sole discretion of Elation Professional. All products covered by this warranty were manufactured after January 1, 1990, and bare identifying marks to that effect.

E. Elation Professional reserves the right to make changes in design and/or performance improvements upon its products without any obligation to include these changes in any products theretofore manufactured.

F. No warranty, whether expressed or implied, is given or made with respect to any accessory supplied with the products described above. Except to the extent prohibited by applicable law, all implied warranties made by Elation Professional in connection with this product, including warranties of merchantability or fitness, are limited in duration to the warranty periods set forth above. And no warranties, whether expressed or implied, including warranties of merchantability or fitness, shall apply to this product after said periods have expired. The consumer's and/or dealer's sole remedy shall be such repair or replacement as is expressly provided above; and under no circumstances shall Elation Professional be liable for any loss and/or damage, direct and/or consequential, arising out of the use of, and/or the inability to use, this product.

G. This warranty is the only written warranty applicable to Elation Professional products and supersedes all prior warranties and written descriptions of warranty terms and conditions heretofore published.

# SAFETY GUIDELINES

This fixture is a sophisticated piece of electronic equipment. To guarantee a smooth operation, it is important to follow all instructions and guidelines in this manual. Elation Professional is not responsible for injury and/or damages resulting from the misuse of this fixture due to the disregard of the information printed in this manual. Only qualified and/or certified personnel should perform installation of this fixture and only the original rigging parts (omega brackets) included with this fixture should be used for installation. Any modifications to the fixture and/or the included mounting hardware will void the original manufactures warranty and increase the risk of damage and/or personal injury.



## **PROTECTION CLASS 1 - FIXTURE MUST BE PROPERLY GROUNDED**

**THERE ARE NO USER SERVICEABLE PARTS INSIDE THIS UNIT. DO NOT ATTEMPT ANY REPAIRS YOURSELF; DOING SO WILL VOID YOUR MANUFACTURES WARRANTY. DAMAGES RESULTING FROM MODIFICATIONS TO THIS FIXTURE AND/OR THE DISREGARD OF SAFETY INSTRUCTIONS AND GUIDELINES IN THIS MANUAL VOID THE MANUFACTURES WARRANTY AND ARE NOT SUBJECT TO ANY WARRANTY CLAIMS AND/OR REPAIRS.**



**DO NOT PLUG FIXTURE INTO A DIMMER PACK!  
NEVER OPEN THIS FIXTURE WHILE IN USE!  
UNPLUG POWER BEFORE SERVICING FIXTURE!  
NEVER TOUCH FIXTURE DURING OPERATION, AS IT MAY BE HOT!  
KEEP FLAMMABLE MATERIALS AWAY FROM FIXTURE!**



**ENSURE ALL CONNECTIONS AND END CAPS ARE PROPERLY SEALED WITH A DIELECTRIC GREASE (AVAILABLE AT MOST ELECTRICAL SUPPLIERS) TO PREVENT WATER CORROSION AND/OR ELECTRICAL SHORT CIRCUIT.**



**NEVER LOOK DIRECTLY INTO THE LIGHT SOURCE!  
RETINA INJURY RISK - MAY INDUCE BLINDNESS!  
SENSITIVE PERSONS MAY SUFFER AN EPILEPTIC SHOCK!**

## **S A F E T Y   G U I D E L I N E S**

**DO NOT TOUCH** the fixture housing during operation. Turn OFF the power and allow approximately 15 minutes for the fixture to cool down before serving.

**DO NOT** shake fixture, avoid brute force when installing and/or operating fixture.

**DO NOT** operate fixture if the power cord is frayed, crimped, damaged and/or if any of the power cord connectors are damaged and do not insert into the fixture securely with ease.

**NEVER** force a power cord connector into the fixture. If the power cord or any of its connectors are damaged, replace it immediately with a new one of similar power rating.

**DO NOT** block any air ventilation slots.

All fan and air inlets must remain clean and never blocked.

Allow approx. 6” (15cm) between fixture and other devices or a wall for proper cooling.

When installing fixture in a suspended environment, always use mounting hardware that is no less than M10 x 25 mm, and always install fixture with an appropriately rated safety cable.

Always disconnect fixture from main power source before performing any type of service and/or cleaning procedure. Only handle the power cord by the plug end, never pull out the plug by tugging the wire portion of the cord.

During the initial operation of this fixture, a light smoke or smell may emit from the interior of the fixture. This is a normal process and is caused by excess paint in the interior of the casing burning off from the heat associated with the lamp and will decrease gradually over time.

Consistent operational breaks will ensure fixture will function properly for many years.

**ONLY** use the original packaging and materials to transport the fixture in for service.

# MAINTENANCE GUIDELINES



**DISCONNECT POWER BEFORE PERFORMING ANY MAINTENANCE!**

## CLEANING

Frequent cleaning is recommended to insure proper function, optimized light output, and an extended life. The frequency of cleaning depends on the environment in which the fixture operates: damp, smoky or particularly dirty environments can cause greater accumulation of dirt on the fixture's optics. Clean the external lens surface at least every 20 days with a soft cloth to avoid dirt/debris accumulation.

**NEVER** use alcohol, solvents, or ammonia-based cleaners.

## MAINTENANCE

Regular inspections are recommended to insure proper function and extended life.

There are no user serviceable parts inside this fixture, please refer all other service issues to an authorized Elation service technician. Should you need any spare parts, please order genuine parts from your local Elation dealer.

Please refer to the following points during routine inspections:

A detailed electric check by an approved electrical engineer every three months, to make sure the circuit contacts are in good condition and prevent overheating.

Be sure all screws and fasteners are securely tightened at all times. Loose screws may fall out during normal operation resulting in damage or injury as larger parts could fall.

Check for any deformations on the housing, color lenses, rigging hardware and rigging points (ceiling, suspension, trussing). Deformations in the housing could allow for dust to enter into the fixture. Damaged rigging points or unsecured rigging could cause the fixture to fall and seriously injure a person(s).

Electric power supply cables must not show any damage, material fatigue or sediments.

**NEVER** remove the ground prong from the power cable.



# FIXTURE OVERVIEW

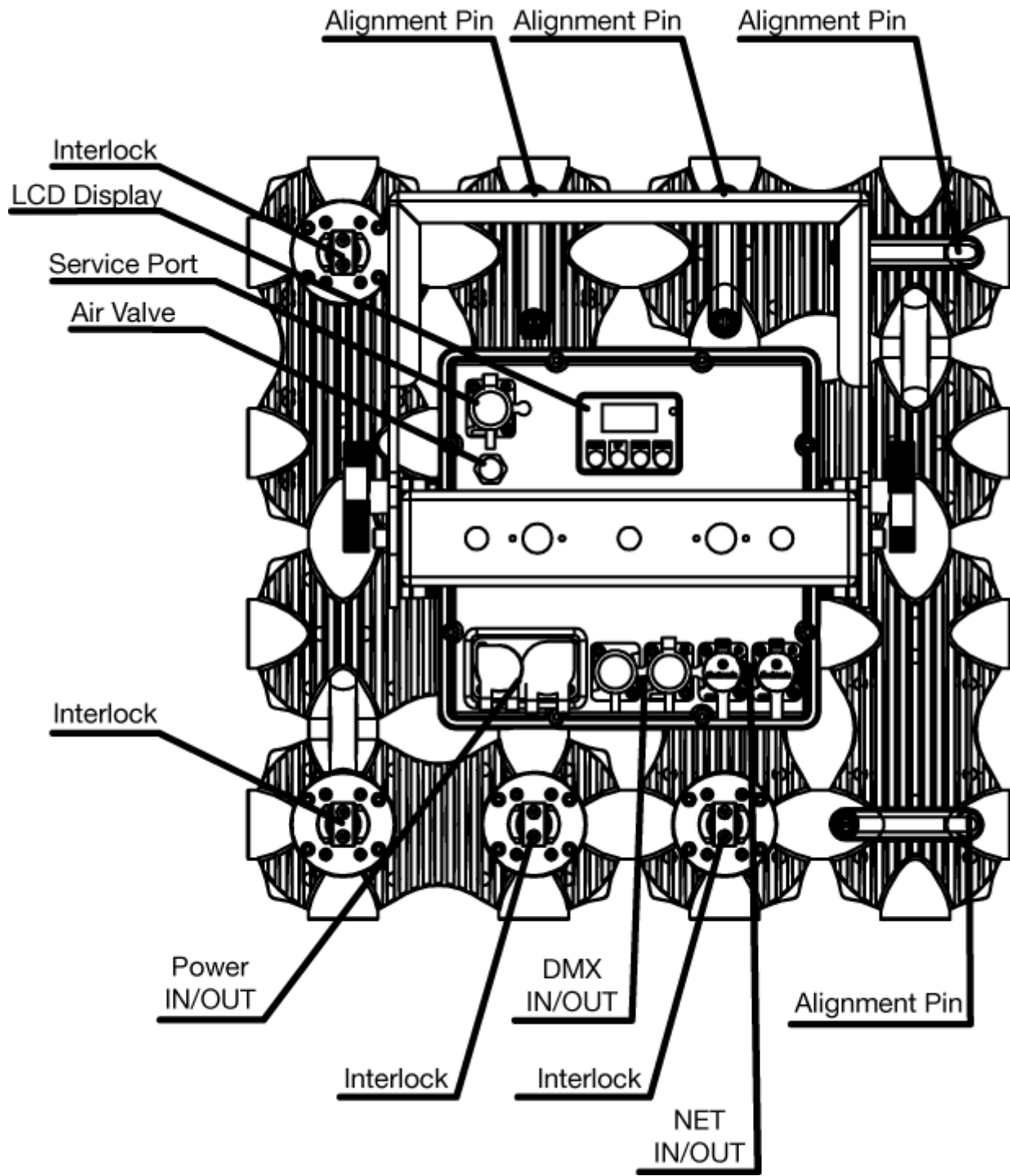

## INCLUDED ITEMS

- Safety Cable
- IP65 Power Cable

# INSTALLATION INSTRUCTIONS

## IP65 RATED

An IP rated lighting fixture is one, which is commonly installed in outdoor environments and has been designed with an enclosure that effectively protects the ingress (entry) of external foreign objects such as dust and water. The **International Protection (IP)** rating system is commonly expressed as "**IP**" (Ingress Protection) followed by two numbers (i.e. IP65) where the numbers define the degree of protection. The first digit (Foreign Bodies Protection) indicates the extent of protection against particles entering the fixture and the second digit (Water Protection) indicates the extent of protection against water entering the fixture. An IP65 rated lighting fixture is one, which has been designed and tested to protect against the ingress of dust (6) and high-pressure water jets from any direction (5).

## MARINE/COASTAL ENVIRONMENT INSTALLATIONS

Please note although this fixture is IP rated, the fixture is **NOT** suitable for marine and/or coastal environment installations. Installing this fixture in a marine and/or coastal environment may cause corrosion and/or excessive wear to the interior and/or exterior components of the fixture. Damages and/or performance issues resulting from installation in a marine and/or coastal environment will void the manufactures warranty and will **NOT** be subject to any warranty claims and/or repairs.

## OPTIONAL CORROSION-RESISTANT COATING

Optional Corrosion-Resistant Coatings may be available for this fixture. Please contact **Elation Professional** for more details.



### FLAMMABLE MATERIAL WARNING

Keep fixture minimum 5.0 feet (1.5m) away from flammable materials and/or pyrotechnics.



### ELECTRICAL CONNECTIONS

A qualified electrician should be used for all electrical connections and/or installations.



**ENSURE ALL CONNECTIONS AND END CAPS ARE PROPERLY SEALED WITH A NON-CONDUCTIVE DIELECTRIC GREASE (AVAILABLE AT MOST ELECTRICAL SUPPLIERS) TO PREVENT WATER INGRESS/CONDENSATION AND/OR CORROSION.**



**USE CAUTION WHEN POWER LINKING OTHER MODEL FIXTURES AS THE POWER CONSUMPTION OF OTHER MODEL FIXTURES MAY EXCEED THE MAX POWER OUTPUT ON THIS FIXTURE. CHECK SILK SCREEN FOR MAX AMPS.**

# INSTALLATION INSTRUCTIONS



**DO NOT INSTALL THE FIXTURE IF YOU ARE NOT QUALIFIED TO DO SO!**

Fixture **MUST** be installed following all local, national, and country commercial electrical and construction codes and regulations.

Before rigging/mounting a single fixture or multiple interconnected fixtures for custom matrix designs to any metal truss/structure or placing the fixture(s) on any surface, a professional equipment installer **MUST** be consulted to determine if the metal truss/structure or surface is properly certified to safely hold the combined weight of the fixture(s), clamps, cables, and accessories.

Fixture ambient operating temperature range is **14° to 113°F. (-10° to 45°C)**

Do not use the fixture under or above this temperature.

Fixture(s) should be installed in areas outside walking paths, seating areas, or away from areas where unauthorized personnel might reach the fixture by hand.

**NEVER** stand directly below the fixture(s) when rigging, removing or servicing.

Overhead fixture installation must always be secured with a secondary safety attachment, such as an appropriately rated safety cable that can hold 10 times the weight of the fixture.

Allow approximately 15 minutes for the fixture to cool down before serving.



**TO MAINTAIN IP65 RATING INTEGRITY AND PREVENT WATER FROM ENTERING FIXTURE, ALL UNUSED CONNECTION RUBBER CAPS MUST BE SEALED.**

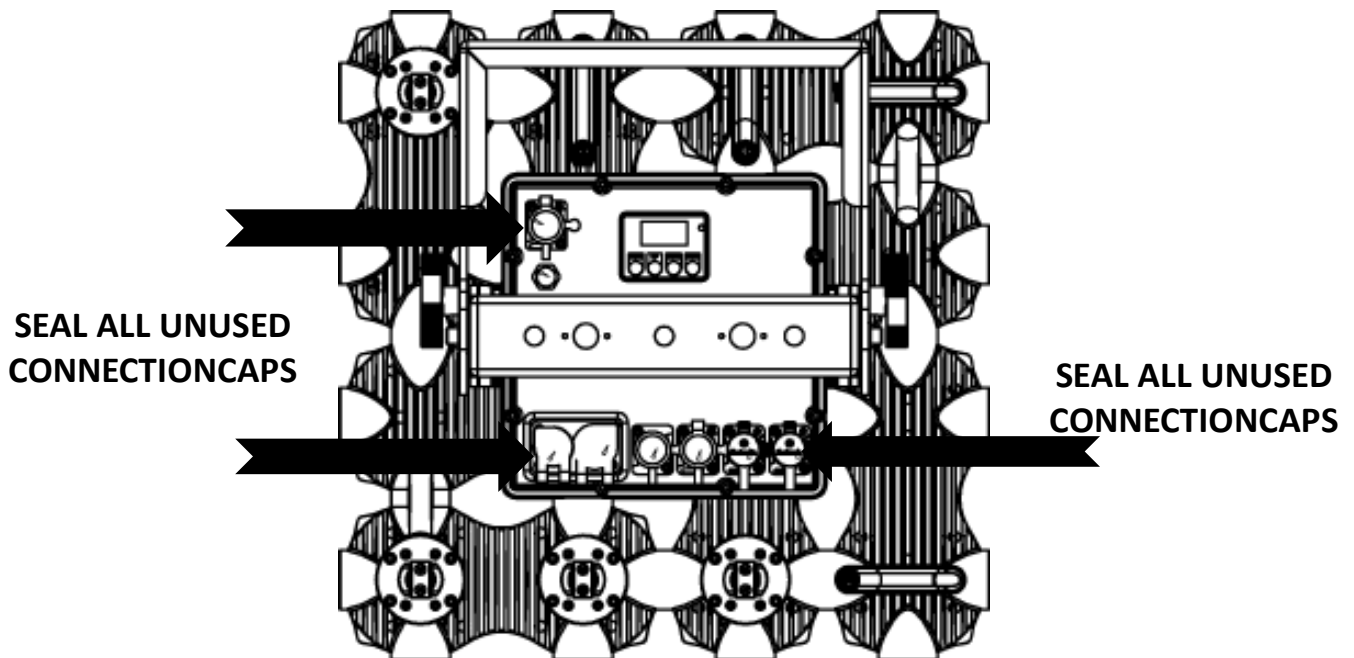

# INSTALLATION INSTRUCTIONS

## CLAMP MOUNTING

A 90-degree adjustable yoke bracket and a fixed yoke bracket are attached to the fixture, both include 3-position holes for versatile fixture positioning. Optional Omega Brackets are available which can be attached to yoke brackets for easy clamp rigging. See the Optional Accessories at the end of this manual for the order code. When mounting this fixture to truss or a metal structure, be sure to secure an appropriately rated clamp (not included) to one of the yoke brackets using an M10 screw. Depending on rigging position of the fixture, it may be best to use more than one clamp attached to the yoke.



**WHEN USING THE 90-DEGREE ADJUSTABLE YOKE TO MOUNT THE FIXTURE, MAKE SURE BOTH YOKE HANDLE KNOBS ARE SECURELY TIGHTEN CLOCKWISE.**

## SAFETY CABLE

The fixture includes 2 integrated safety cable rigging points. (see image below)



**ALWAYS ATTACH A SAFETY CABLE WHENEVER INSTALLING THIS FIXTURE IN A SUSPENDED ENVIRONMENT TO ENSURE THE FIXTURE WILL NOT DROP IF THE CLAMP FAILS.**

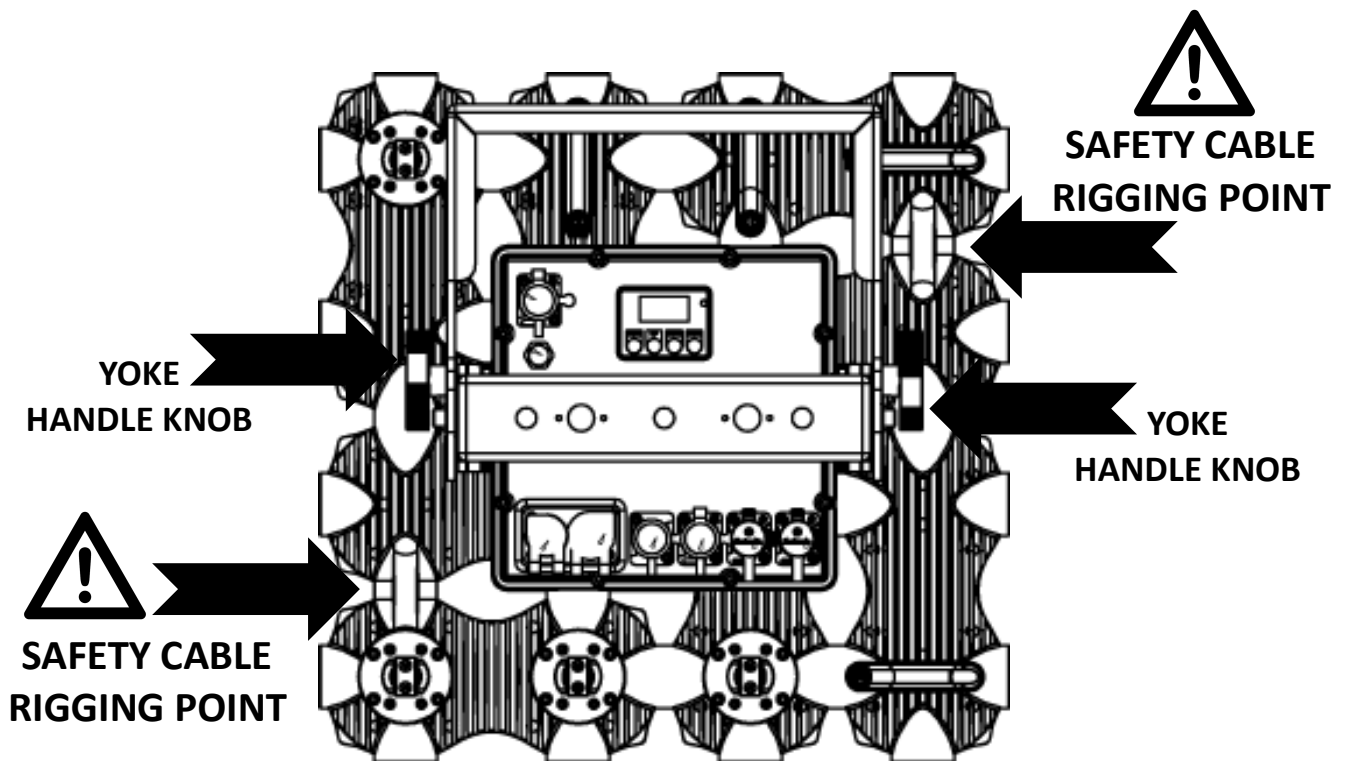

# INSTALLATION INSTRUCTIONS

## INTERLOCKING PANELS

The fixture includes integrated alignment pins and interlocks which are used to connect multiple panels together horizontally and vertically to create seamless custom matrix designs. See images below for interlocking steps.



**THE PINS AND INTERLOCKS ARE FOR ALIGNMENT PURPOSES ONLY!  
EACH PANEL MUST BE SECURED WITH ITS OWN CLAMP(S) AND SAFETY CABLE!  
FOR MULTIPLE PANEL RIGGING, USE ONLY THE FIXED YOKE BRACKET!**

1. Push out alignment pins on panel by pulling up and holding round knob while sliding out. Release round knob to lock alignment pin into fully extended position. **MAKE SURE EACH ALIGNMENT PIN IS FULLY EXTENDED OUT AND THE ROUND TAB IS IN THE LOCKED POSITION!**

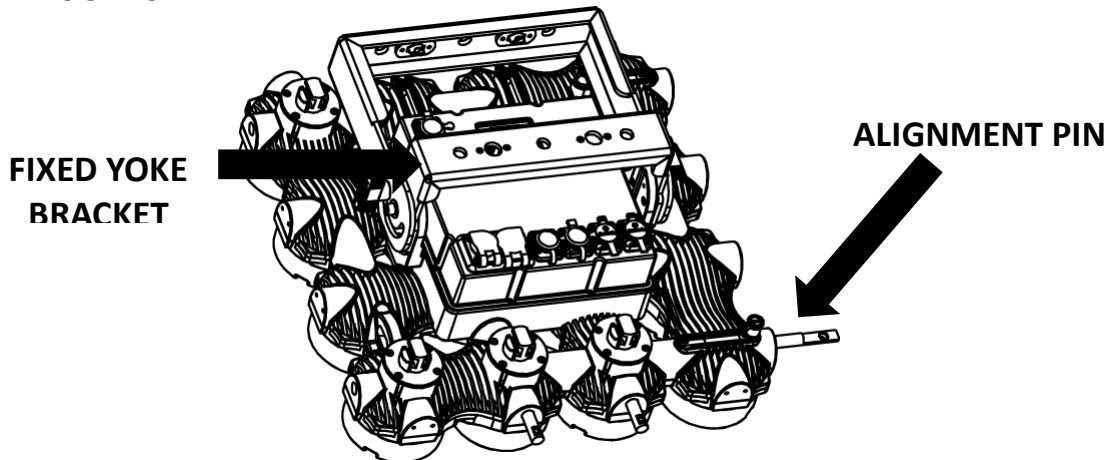

2. UNLOCK/OPEN interlocks on panel by pulling up and holding lock while turning 45 degrees to 9/3 o'clock position. Release lock so it sits completely into position. **MAKE SURE EACH INTERLOCK IS COMPLETELY IN THE 9/3 O'CLOCK UNLOCK/OPEN POSITION!**

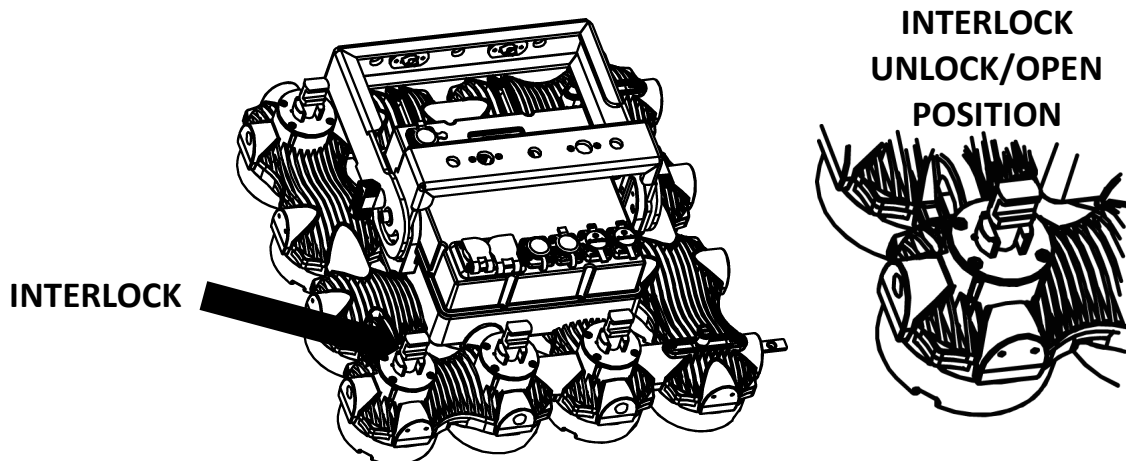

# INSTALLATION INSTRUCTIONS

## INTERLOCKING PANELS

3. Push panels together (horizontally and/or vertically) by inserting alignment pins of one panel into the marrying interlocks of another panel. Once alignment pins are fully inserted, LOCK/CLOSE interlocks on panels by pulling up and holding lock while turning 45 degrees to 12/6 o'clock position. **MAKE SURE EACH INTERLOCK IS COMPLETELY IN THE 12/6 O'CLOCK LOCK/CLOSE POSITION AND EACH ALIGNMENT PIN ROUND TAB IS IN THE LOCKED POSITION!**

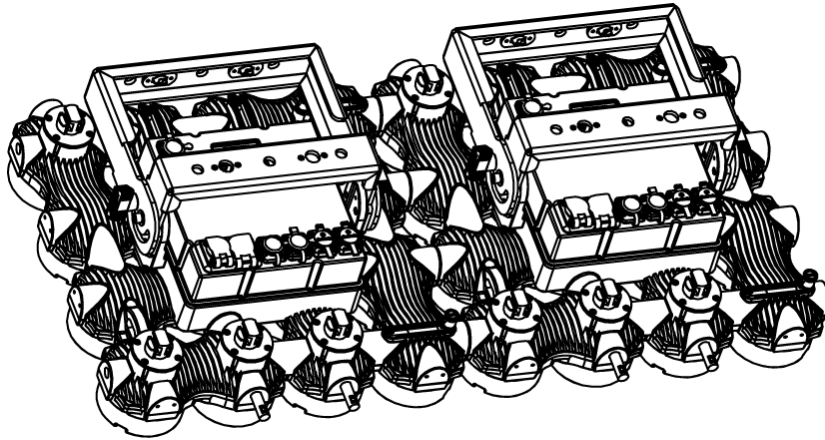

INTERLOCK  
LOCK/CLOSE  
POSITION



4. Repeat steps 1-3 for as needed for each horizontally/vertically connected panel.

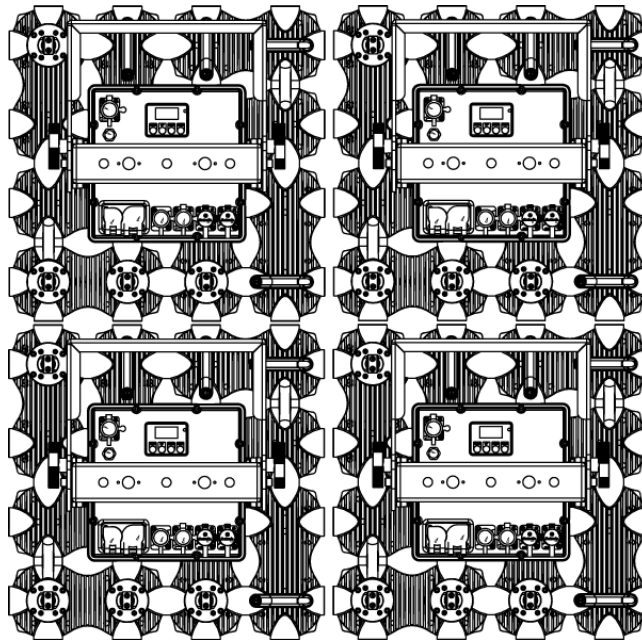

## OVERHEAD RIGGING

Overhead rigging requires extensive experience, including amongst others calculating working load limits, installation material being used, and periodic safety inspection of all installation material and the fixture. If you lack these qualifications, do not attempt the installation yourself. Improper installation can result in bodily injury and property damage.

# INSTALLATION INSTRUCTIONS

## POWER LINKING



USE CAUTION WHEN POWER LINKING OTHER MODEL FIXTURES AS THE POWER CONSUMPTION OF OTHER MODEL FIXTURES MAY EXCEED THE MAX POWER OUTPUT ON THIS FIXTURE. CHECK SILK SCREEN FOR MAX AMPS.

## KLING-NET / ART-NET CONNECTION

When connecting fixture to a network switch to control multiple devices, a **Gigabit Ethernet Switch** that supports **IGMP (Internet Group Management Protocol)** is required. Using a **Gigabit Ethernet Switch** that does not support **IGMP** can cause erratic behavior of all connected devices to the switch. Click link below for more information about IGMP.

[https://en.wikipedia.org/wiki/Internet\\_Group\\_Management\\_Protocol](https://en.wikipedia.org/wiki/Internet_Group_Management_Protocol)

## SYSTEM MENU

The fixture includes an easy to navigate system menu where fixture settings can be adjusted via the LCD control panel located on the back of the fixture. (see image below) During normal operation, pressing the **MODE** button once will access the main menu. Navigate through the various sub-menus by pressing the **UP** and **DOWN** buttons, press the **ENTER** button to select a specific sub-menu, press the **UP** and **DOWN** buttons to adjust the selected sub-menu settings, and press the **ENTER** button again to confirm the sub-menu setting selection. Exit the main system menu at any time without making any adjustments by pressing the **MODE** button.

To access the system menu press and hold the **MODE** button for 3 seconds. The LCD Menu Control Display will shut **OFF** automatically about 1 minute from the last button press.

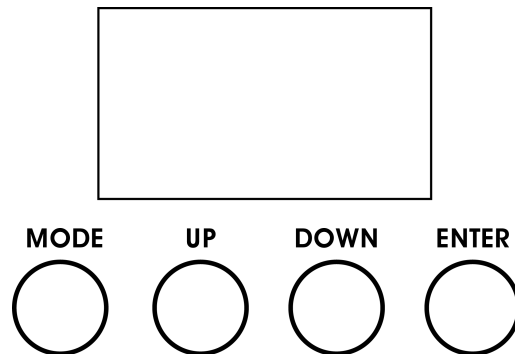



## SYSTEM MENU

Supports Software Versions: ≥ 1.04

Features are subject to change without any prior written notice.

MENU	SUB MENU	OPTIONS / VALUES (Default Settings in BOLD)	DESCRIPTION	
Address	ADDR:	<b>001</b> ~ xxx	DMX Address Setting	
UserMode		<b>03CH</b> , 04CH, 07CH, 07CH, 06CH, 08CH, 08CH, 11CH, 12CH, 12CH, 48CH, 64CH, 72CH, 128CH	Set DMX Channel / User Mode	
Function	Status	No Dmx <b>Black / Hold</b>	Function If NO DMX Detected	
	LCD.Set	Display	<b>ON</b> / OFF	LCD Backlight Shut Off Time
		Key Lock	<b>ON</b> / OFF	Control Front Panel Buttons Key Lock
		Flash	<b>ON</b> / OFF	Display flashes when NO DMX
		Invert	ON / <b>OFF</b>	Flips Display 180 Degrees
	Temp. C/F	<b>F</b> / C	Temperature Switch Between F° / C°	
	DimCurve	<b>Standard</b> , Stage, TV, Architec, Theatre, Stage2	Set Dimmer Curve Mode	
	Disp.Set	ADDR, Disp.CH, Slave	Select Default Display	
	Flip	<b>Standard</b> , Flip1, Flip2, Flip3, Flip4	Set Pixel Flip Mode (See page 19 for more info)	
	Macro	00-63	Select Internal Color Macro	
	Gamma	<b>2.0</b> , 2.2, 2.4, 2.8	Set Gamma Brightness	
	Frequen	<b>900Hz</b> , 1000Hz, 1100Hz, 1200Hz, 1300Hz, 1400Hz, 1500Hz, 2500Hz, 4000Hz, 5000Hz, 10Hz, 15Hz, 20Hz, 25Hz	Set LED Refresh Frequency	
	PROTOCOL	<b>ArtNet</b> , KlingNet	Select Network Protocol	
	NET_SWIT	ON / <b>OFF</b>	Enable Network Protocol Auto-Detection	
	FIX_ID	Password	<b>050</b>	Enter Password to Access Fixture ID Menu
		DeviceIP	XXX.XXX.XXX.XXX	Enter Device IP Address
Universe		<b>000</b> -255	Enter Device Universe	
DFSE	ON / <b>OFF</b>	Restore Factory Settings		
USB	ON / <b>OFF</b>	Enable Service Port for Software Updates		
Info	TimeInfo	Current	XXXX (Hours)	Fixture Run Time from Power ON
		Total	XXXX (Hours)	Fixture Total Run Time
		Last PassWord	XXXX (Hours)	Clear Fixture Last Run Time
		TimerPIN	PIN= <b>066</b>	Enter PIN to Access Clear Last. Menu
	TempInfo	LED Temp	XXX F° / C°	Temperature in Fixture Head
	Err.Info	Error Record 1 ~ Error Record 10	Display 10 Recent Error Messages	
	Modellnf	<b>Cuepix 16 IP</b>	Display Model Name	
SoftWare	≥V1.04	Software Versions		

**Supports Software Versions: ≥ 1.04**

Features are subject to change without any prior written notice.

<b>MENU</b>	<b>SUB MENU</b>	<b>OPTIONS / VALUES (Default Settings in BOLD)</b>		<b>DESCRIPTION</b>		
Manual	Manual	Strobe	<b>000</b> - 255	Set Strobe DMX Value		
		Dimmer	<b>000</b> - 255	Set Master Dimmer DMX Value		
		DimFine	<b>000</b> - 255	Set Dimmer Fine DMX Value		
		DimMode	<b>000</b> - 255	Select Dimmer Curve Mode		
		Red1	<b>000</b> - 255	Set RGBA DMX Values of Pixel #1		
		Green1	<b>000</b> - 255			
		Blue1	<b>000</b> - 255			
		Amber1	<b>000</b> - 255			
		Red2	<b>000</b> - 255	Set RGBA DMX Values of Pixel #2		
		Green2	<b>000</b> - 255			
		Blue2	<b>000</b> - 255			
		Amber2	<b>000</b> - 255			
		▼		▼		▼
		Red15	<b>000</b> - 255	Set RGBA DMX Values of Pixel #15		
		Green15	<b>000</b> - 255			
		Blue15	<b>000</b> - 255			
Amber15	<b>000</b> - 255					
Red16	<b>000</b> - 255	Set RGBA DMX Values of Pixel #16				
Green16	<b>000</b> - 255					
Blue16	<b>000</b> - 255					
Amber16	<b>000</b> - 255					
Test	ManCtrl	Strobe	<b>000</b> - 255	Set Strobe DMX Value		
		Dimmer	<b>000</b> - 255	Set Master Dimmer DMX Value		
		DimFine	<b>000</b> - 255	Set Dimmer Fine DMX Value		
		DimMode		Select Dimmer Curve Mode		
		Red1	<b>000</b> - 255	Set RGBA DMX Values of Pixel #1		
		Green1	<b>000</b> - 255			
		Blue1	<b>000</b> - 255			
		Amber1	<b>000</b> - 255			
		Red2	<b>000</b> - 255	Set RGBA DMX Values of Pixel #2		
		Green2	<b>000</b> - 255			
		Blue2	<b>000</b> - 255			
		Amber2	<b>000</b> - 255			
		▼		▼		▼
	Red15	<b>000</b> - 255	Set RGBA DMX Values of Pixel #15			
	Green15	<b>000</b> - 255				
	Blue15	<b>000</b> - 255				
	Amber15	<b>000</b> - 255				
Red16	<b>000</b> - 255	Set RGBA DMX Values of Pixel #16				
Green16	<b>000</b> - 255					
Blue16	<b>000</b> - 255					
Amber16	<b>000</b> - 255					
	Calibrat	Password	<b>050</b>	Enter Password to Access Calibration Menu <b>NOTE: ONLY QUALIFIED TECHNICIANS SHOULD PERFORM THIS FUNCTION!</b>		

# PIXEL CONTROL

There are 5 pixel modes which can be selected from the FLIP sub menu in the FUNCTION main system menu, each having a different starting pixel location and sequence on the panel. This feature makes it easy to configure the pixels of all panels to be the same regardless of their installation orientation. See diagrams below for each pixel flip mode.

**STANDARD**

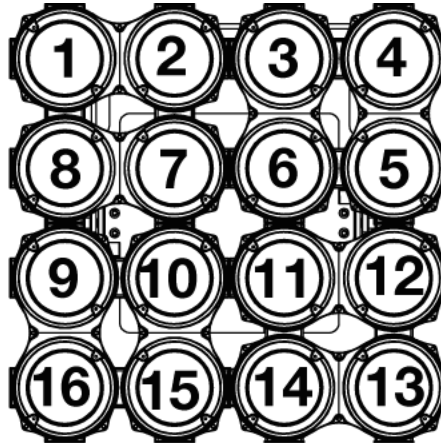

**FLIP 1**

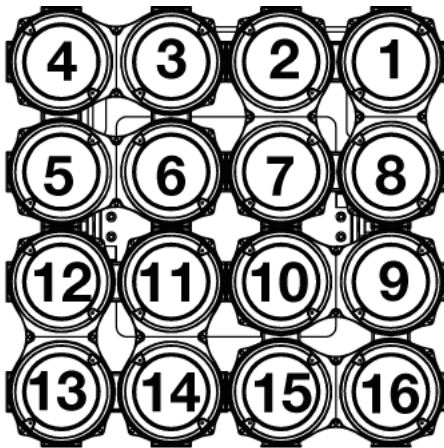

**FLIP 2**

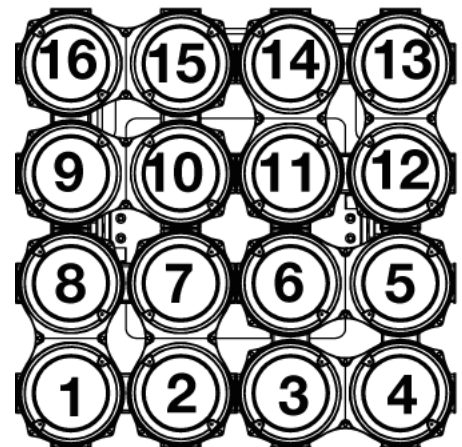

**FLIP 3**

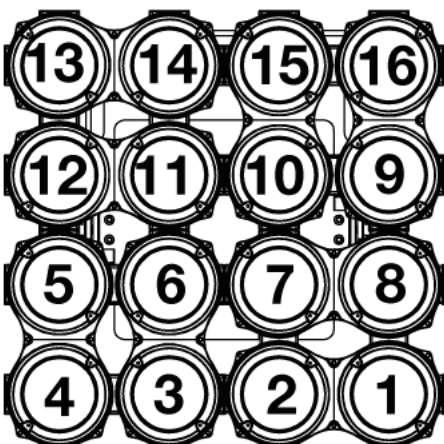

**FLIP 4**

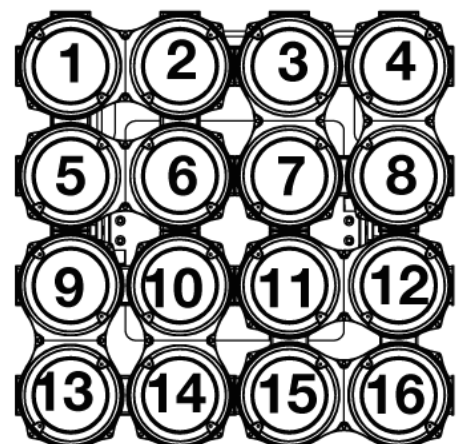

# DMX CHANNEL FUNCTIONS AND VALUES

DMX Channel Values / Functions (128 DMX Channels)

Supports Software Versions:  $\geq 1.05$

Features subject to change without any prior written notice.

**\*Pixel control of effects depends on flip system menu settings.**

**DYNAMIC AMBER AUTOMATICALLY ADDED TO RGB CHANNELS**

**MODE / CHANNEL**

03CH RGB	04CH RGBA	07CH RGBA+	07CH DA+	06CH RGBI	08CH 16Bit	08CH RGBA	11CH Basic	12CH RGBA	12CH RGBI	VALUE	FUNCTION
											SHUTTER / STROBE
				1					1	0-31	LED OFF
										32-63	LED ON
										64-95	Strobe Effect SLOW to FAST
										96-127	LED ON
										128-159	Strobe Pulse Effect In Sequences SLOW to FAST
										160-191	LED ON
										192-223	Random Strobe Effect SLOW to FAST
										224-255	LED ON
1	1	1	1	2	1	1	1	1	2		RED - ALL PIXELS
					2					0-255	0-100%
											RED FINE - ALL PIXELS
										0-255	16-bit FINE Adjustment
2	2	2	2	3	3	2	2	2	3		GREEN - ALL PIXELS
										0-255	0-100%
											GREEN FINE - ALL PIXELS
										0-255	16-bit FINE Adjustment
3	3	3	3	4	5	3	3	3	4		BLUE - ALL PIXELS
										0-255	0-100%
											BLUE FINE - ALL PIXELS
										0-255	16-bit FINE Adjustment
	4	4	4	5	7	4	4	4	5		AMBER - ALL PIXELS
										0-255	0-100%
											AMBER FINE - ALL PIXELS
					8					0-255	16-bit FINE Adjustment

**DYNAMIC AMBER AUTOMATICALLY ADDED TO RGB CHANNELS**

MODE / CHANNEL										VALUE	FUNCTION
03CH RGB	04CH RGBA	07CH RGBA+	07CH DA+	06CH RGBI	08CH 16Bit	08CH RGBA	11CH Basic	12CH RGBA	12CH RGBI		
											<b>COLOR MACROS</b>
											1-4 Color Macro 01
											5-8 Color Macro 02
											9-12 Color Macro 03
											13-16 Color Macro 04
											17-20 Color Macro 05
											21-24 Color Macro 06
											25-28 Color Macro 07
											29-32 Color Macro 08
											33-36 Color Macro 09
											37-40 Color Macro 10
											41-44 Color Macro 11
											45-48 Color Macro 12
											49-52 Color Macro 13
											53-56 Color Macro 14
											57-60 Color Macro 15
											61-64 Color Macro 16
											65-68 Color Macro 17
											69-72 Color Macro 18
							5		5		73-76 Color Macro 19
											77-80 Color Macro 20
											81-84 Color Macro 21
											85-88 Color Macro 22
											89-92 Color Macro 23
											93-96 Color Macro 24
											97-100 Color Macro 25
											101-104 Color Macro 26
											105-108 Color Macro 27
											109-112 Color Macro 28
											113-116 Color Macro 29
											117-120 Color Macro 30
											121-124 Color Macro 31
											125-128 Color Macro 32
											129-132 Color Macro 33
											133-136 Color Macro 34
											137-140 Color Macro 35
											141-144 Color Macro 36
											145-148 Color Macro 37
											149-152 Color Macro 38

**DYNAMIC AMBER AUTOMATICALLY ADDED TO RGB CHANNELS**

MODE / CHANNEL										VALUE	FUNCTION
03CH RGB	04CH RGBA	07CH RGBA+	07CH DA+	06CH RGBI	08CH 16Bit	08CH RGBA	11CH Basic	12CH RGBA	12CH RGBI		
											<b>COLOR MACROS (continued)</b>
										153-156	Color Macro 39
										157-160	Color Macro 40
										161-164	Color Macro 41
										165-168	Color Macro 42
										169-172	Color Macro 43
										173-176	Color Macro 44
										177-180	Color Macro 45
										181-184	Color Macro 46
										185-188	Color Macro 47
										189-192	Color Macro 48
										193-196	Color Macro 49
										197-200	Color Macro 50
							5	5		201-204	Color Macro 51
										205-208	Color Macro 52
										209-212	Color Macro 53
										213-216	Color Macro 54
										217-220	Color Macro 55
										221-224	Color Macro 56
										225-228	Color Macro 57
										229-232	Color Macro 58
										233-236	Color Macro 59
										237-240	Color Macro 60
										241-244	Color Macro 61
										245-248	Color Macro 62
										249-252	Color Macro 63
										253-255	Color Macro 64

**DYNAMIC AMBER AUTOMATICALLY ADDED TO RGB CHANNELS**

MODE / CHANNEL										VALUE	FUNCTION
03CH RGB	04CH RGBA	07CH RGBA+	07CH DA+	06CH RGBI	08CH 16Bit	08CH RGBA	11CH Basic	12CH RGBA	12CH RGBI		
						5	6	6			<b>SHUTTER / STROBE</b>
										0-31	LED OFF
										32-63	LED ON
										64-95	Strobe Effect SLOW to FAST
										96-127	LED ON
										128-159	Strobe Pulse Effect In Sequences SLOW to FAST
										160-191	LED ON
										192-223	Random Strobe Effect SLOW to FAST
										224-255	LED ON
		5	5	6		6	7	7	6		<b>MASTER DIMMER / INTENSITY</b>
										0-255	Dimmer (0-100%)
		6	6			7		8	7		<b>MASTER DIMMER / INTENSITY FINE</b>
										0-255	Dimmer (0-100%)
							8	9	8		<b>PROGRAM MACROS</b>
										0-19	NO FUNCTION
										1-20	PROGRAM 01
										21-40	PROGRAM 02
										41-60	PROGRAM 03
										62-80	PROGRAM 04
										81-100	PROGRAM 05
										101-120	PROGRAM 06
										121-140	PROGRAM 07
										141-160	PROGRAM 08
										161-180	PROGRAM 09
										181-200	PROGRAM 10
										201-220	PROGRAM 11
										221-240	PROGRAM 12
										241-250	PROGRAM 13
										251-255	PROGRAM 14
							9	10	9		<b>PROGRAM MACRO SPEED</b>
										0-255	Program Macro SPEED SLOW to FAST
							10	11	10		<b>PROGRAM MACRO FADE</b>
										0-255	Program Macro FADE SLOW to FAST

**DYNAMIC AMBER AUTOMATICALLY ADDED TO RGB CHANNELS**

MODE / CHANNEL										VALUE	FUNCTION
03CH RGB	04CH RGBA	07CH RGBA+	07CH DA+	06CH RGBI	08CH 16Bit	08CH RGBA	11CH Basic	12CH RGBA	12CH RGBI		
											<b>COLOR MACROS</b>
										1-4	Color Macro 01
										5-8	Color Macro 02
										9-12	Color Macro 03
										13-16	Color Macro 04
										17-20	Color Macro 05
										21-24	Color Macro 06
										25-28	Color Macro 07
										29-32	Color Macro 08
										33-36	Color Macro 09
										37-40	Color Macro 10
										41-44	Color Macro 11
										45-48	Color Macro 12
										49-52	Color Macro 13
										53-56	Color Macro 14
										57-60	Color Macro 15
										61-64	Color Macro 16
										65-68	Color Macro 17
										69-72	Color Macro 18
										73-76	Color Macro 19
										77-80	Color Macro 20
										81-84	Color Macro 21
										85-88	Color Macro 22
										89-92	Color Macro 23
										93-96	Color Macro 24
										97-100	Color Macro 25
										101-104	Color Macro 26
										105-108	Color Macro 27
										109-112	Color Macro 28
										113-116	Color Macro 29
										117-120	Color Macro 30
										121-124	Color Macro 31
										125-128	Color Macro 32
										129-132	Color Macro 33
										133-136	Color Macro 34
										137-140	Color Macro 35
										141-144	Color Macro 36
										145-148	Color Macro 37
										149-152	Color Macro 38



**DYNAMIC AMBER AUTOMATICALLY ADDED TO RGB CHANNELS**

MODE / CHANNEL										VALUE	FUNCTION
03CH RGB	04CH RGBA	07CH RGBA+	07CH DA+	06CH RGBI	08CH 16Bit	08CH RGBA	11CH Basic	12CH RGBA	12CH RGBI		
											<b>COLOR MACROS (continued)</b>
										11	153-156 Color Macro 39
											157-160 Color Macro 40
											161-164 Color Macro 41
											165-168 Color Macro 42
											169-172 Color Macro 43
											173-176 Color Macro 44
											177-180 Color Macro 45
											181-184 Color Macro 46
											185-188 Color Macro 47
											189-192 Color Macro 48
											193-196 Color Macro 49
											197-200 Color Macro 50
											201-204 Color Macro 51
											205-208 Color Macro 52
											209-212 Color Macro 53
											213-216 Color Macro 54
											217-220 Color Macro 55
											221-224 Color Macro 56
											225-228 Color Macro 57
											229-232 Color Macro 58
											233-236 Color Macro 59
											237-240 Color Macro 60
											241-244 Color Macro 61
											245-248 Color Macro 62
											249-252 Color Macro 63
											253-255 Color Macro 64
											<b>DIMMING MODES</b>
										12	0-20 STANDARD
											21-40 STAGE
		7	7			8	11	12			41-60 TV
											61-80 ARCHITECTURAL
											81-100 THEATER
											101-120 STAGE 2
											121-255 DEFAULT TO UNIT SETTING

**DYNAMIC AMBER AUTOMATICALLY ADDED TO RGB CHANNELS**

<b>MODE / CHANNEL</b>					<b>VALUE</b>	<b>FUNCTION</b>
<b>48CH DA</b>	<b>64CH RGBA</b>	<b>72CH Pixel</b>	<b>128CH 16Bit</b>			
1	1	1	1		RED - PIXEL 1	
				0-255	0-100%	
			2		RED FINE - PIXEL 1	
				0-256	16-bit FINE Adjustment	
2	2	2	3		GREEN - PIXEL 1	
				0-255	0-100%	
			4		GREEN FINE - PIXEL 1	
				0-256	16-bit FINE Adjustment	
3	3	3	5		BLUE - PIXEL 1	
				0-255	0-100%	
			6		BLUE FINE - PIXEL 1	
				0-256	16-bit FINE Adjustment	
	4	4	7		AMBER - PIXEL 1	
				0-256	0-100%	
			8		AMBER FINE - PIXEL 1	
				0-257	16-bit FINE Adjustment	
4	5	5	9		RED - PIXEL 2	
				0-255	0-100%	
			10		RED FINE - PIXEL 2	
				0-256	16-bit FINE Adjustment	
5	6	6	11		GREEN - PIXEL 2	
				0-255	0-100%	
			12		GREEN FINE - PIXEL 2	
				0-256	16-bit FINE Adjustment	
6	7	7	13		BLUE - PIXEL 2	
				0-255	0-100%	
			14		BLUE FINE - PIXEL 2	
				0-256	16-bit FINE Adjustment	
	8	8	15		AMBER - PIXEL 2	
				0-256	0-100%	
			16		AMBER FINE - PIXEL 2	
				0-257	16-bit FINE Adjustment	
7	9	9	17		RED - PIXEL 3	
				0-255	0-100%	
			18		RED FINE - PIXEL 3	
				0-255	16-bit FINE Adjustment	
8	10	10	19		GREEN - PIXEL 3	
				0-255	0-100%	
			20		GREEN FINE - PIXEL 3	
				0-256	16-bit FINE Adjustment	
9	11	11	21		BLUE - PIXEL 3	
				0-255	0-100%	
			22		BLUE FINE - PIXEL 3	
				0-255	16-bit FINE Adjustment	
	12	12	23		AMBER - PIXEL 3	
				0-256	0-100%	
			24		AMBER FINE - PIXEL 3	
				0-256	16-bit FINE Adjustment	

**DYNAMIC AMBER AUTOMATICALLY ADDED TO RGB CHANNELS**

MODE / CHANNEL				VALUE	FUNCTION
48CH DA	64CH RGBA	72CH Pixel	128CH 16Bit		
10	13	13	25		RED - PIXEL 4
				0-255	0-100%
			26		RED FINE - PIXEL 4
				0-255	16-bit FINE Adjustment
11	14	14	27		GREEN - PIXEL 4
				0-255	0-100%
			28		GREEN FINE - PIXEL 4
				0-255	16-bit FINE Adjustment
12	15	15	29		BLUE - PIXEL 4
				0-255	0-100%
			30		BLUE FINE - PIXEL 4
				0-255	16-bit FINE Adjustment
	16	16	31		AMBER - PIXEL 4
				0-256	0-100%
			32		AMBER FINE - PIXEL 4
				0-256	16-bit FINE Adjustment
13	17	17	33		RED - PIXEL 5
				0-255	0-100%
			34		RED FINE - PIXEL 5
				0-255	16-bit FINE Adjustment
14	18	18	35		GREEN - PIXEL 5
				0-255	0-100%
			36		GREEN FINE - PIXEL 5
				0-255	16-bit FINE Adjustment
15	19	19	37		BLUE - PIXEL 5
				0-255	0-100%
			38		BLUE FINE - PIXEL 5
				0-255	16-bit FINE Adjustment
	20	20	39		AMBER - PIXEL 5
				0-256	0-100%
			40		AMBER FINE - PIXEL 5
				0-256	16-bit FINE Adjustment
16	21	21	41		RED - PIXEL 6
				0-255	0-100%
			42		RED FINE - PIXEL 6
				0-255	16-bit FINE Adjustment
17	22	22	43		GREEN - PIXEL 6
				0-255	0-100%
			44		GREEN FINE - PIXEL 6
				0-255	16-bit FINE Adjustment
18	23	23	45		BLUE - PIXEL 6
				0-255	0-100%
			46		BLUE FINE - PIXEL 6
				0-255	16-bit FINE Adjustment
	24	24	47		AMBER - PIXEL 6
				0-256	0-100%
			48		AMBER FINE - PIXEL 6
				0-256	16-bit FINE Adjustment

**DYNAMIC AMBER AUTOMATICALLY ADDED TO RGB CHANNELS**

MODE / CHANNEL				VALUE	FUNCTION
48CH DA	64CH RGBA	72CH Pixel	128CH 16Bit		
19	25	25	49		RED - PIXEL 7
				0-255	0-100%
			50		RED FINE - PIXEL 7
				0-255	16-bit FINE Adjustment
20	26	26	51		GREEN - PIXEL 7
				0-255	0-100%
			52		GREEN FINE - PIXEL 7
				0-255	16-bit FINE Adjustment
21	27	27	53		BLUE - PIXEL 7
				0-255	0-100%
			54		BLUE FINE - PIXEL 7
				0-255	16-bit FINE Adjustment
	28	28	5		AMBER - PIXEL 7
				0-256	0-100%
			56		AMBER FINE - PIXEL 7
				0-256	16-bit FINE Adjustment
22	29	29	57		RED - PIXEL 8
				0-255	0-100%
			58		RED FINE - PIXEL 8
				0-255	16-bit FINE Adjustment
23	30	30	59		GREEN - PIXEL 8
				0-255	0-100%
			60		GREEN FINE - PIXEL 8
				0-255	16-bit FINE Adjustment
24	31	31	61		BLUE - PIXEL 8
				0-255	0-100%
			62		BLUE FINE - PIXEL 8
				0-255	16-bit FINE Adjustment
	32	32	63		AMBER - PIXEL 8
				0-256	0-100%
			64		AMBER FINE - PIXEL 8
				0-256	16-bit FINE Adjustment
25	33	33	65		RED - PIXEL 9
				0-255	0-100%
			66		RED FINE - PIXEL 9
				0-255	16-bit FINE Adjustment
26	34	34	67		GREEN - PIXEL 9
				0-255	0-100%
			68		GREEN FINE - PIXEL 9
				0-255	16-bit FINE Adjustment
27	35	35	69		BLUE - PIXEL 9
				0-255	0-100%
			70		BLUE FINE - PIXEL 9
				0-255	16-bit FINE Adjustment
	36	36	71		AMBER - PIXEL 9
				0-256	0-100%
			72		AMBER FINE - PIXEL 9
				0-256	16-bit FINE Adjustment

**DYNAMIC AMBER AUTOMATICALLY ADDED TO RGB CHANNELS**

MODE / CHANNEL				VALUE	FUNCTION
48CH DA	64CH RGBA	72CH Pixel	128CH 16Bit		
28	37	37	73		RED - PIXEL 10
				0-255	0-100%
			74		RED FINE - PIXEL 10
				0-255	16-bit FINE Adjustment
29	38	38	75		GREEN - PIXEL 10
				0-255	0-100%
			76		GREEN FINE - PIXEL 10
				0-255	16-bit FINE Adjustment
30	39	39	77		BLUE - PIXEL 10
				0-255	0-100%
			78		BLUE FINE - PIXEL 10
				0-255	16-bit FINE Adjustment
	40	40	79		AMBER - PIXEL 10
				0-256	0-100%
			80		AMBER FINE - PIXEL 10
				0-256	16-bit FINE Adjustment
31	41	41	81		RED - PIXEL 11
				0-255	0-100%
			82		RED FINE - PIXEL 11
				0-255	16-bit FINE Adjustment
32	42	42	83		GREEN - PIXEL 11
				0-255	0-100%
			84		GREEN FINE - PIXEL 11
				0-255	16-bit FINE Adjustment
33	43	43	85		BLUE - PIXEL 11
				0-255	0-100%
			86		BLUE FINE - PIXEL 11
				0-255	16-bit FINE Adjustment
	44	44	87		AMBER - PIXEL 11
				0-256	0-100%
			88		AMBER FINE - PIXEL 11
				0-256	16-bit FINE Adjustment
34	45	45	89		RED - PIXEL 12
				0-255	0-100%
			90		RED FINE - PIXEL 12
				0-255	16-bit FINE Adjustment
35	46	46	91		GREEN - PIXEL 12
				0-255	0-100%
			92		GREEN FINE - PIXEL 12
				0-255	16-bit FINE Adjustment
36	47	47	93		BLUE - PIXEL 12
				0-255	0-100%
			94		BLUE FINE - PIXEL 12
				0-255	16-bit FINE Adjustment
	48	48	95		AMBER - PIXEL 12
				0-256	0-100%
			96		AMBER FINE - PIXEL 12
				0-256	16-bit FINE Adjustment

**DYNAMIC AMBER AUTOMATICALLY ADDED TO RGB CHANNELS**

MODE / CHANNEL				VALUE	FUNCTION
48CH DA	64CH RGBA	72CH Pixel	128CH 16Bit		
37	49	49	97		RED - PIXEL 13
				0-255	0-100%
			98		RED FINE - PIXEL 13
				0-255	16-bit FINE Adjustment
38	50	50	99		GREEN - PIXEL 13
				0-255	0-100%
			100		GREEN FINE - PIXEL 13
				0-255	16-bit FINE Adjustment
39	51	51	101		BLUE - PIXEL 13
				0-255	0-100%
			102		BLUE FINE - PIXEL 13
				0-255	16-bit FINE Adjustment
	52	52	103		AMBER - PIXEL 13
				0-256	0-100%
			104		AMBER FINE - PIXEL 13
				0-256	16-bit FINE Adjustment
40	53	53	105		RED - PIXEL 14
				0-255	0-100%
			106		RED FINE - PIXEL 14
				0-255	16-bit FINE Adjustment
41	54	54	107		GREEN - PIXEL 14
				0-255	0-100%
			108		GREEN FINE - PIXEL 14
				0-255	16-bit FINE Adjustment
42	55	55	109		BLUE - PIXEL 14
				0-255	0-100%
			110		BLUE FINE - PIXEL 14
				0-255	16-bit FINE Adjustment
	56	56	111		AMBER - PIXEL 14
				0-256	0-100%
			112		AMBER FINE - PIXEL 14
				0-256	16-bit FINE Adjustment
43	57	57	113		RED - PIXEL 15
				0-255	0-100%
			114		RED FINE - PIXEL 15
				0-255	16-bit FINE Adjustment
44	58	58	115		GREEN - PIXEL 15
				0-255	0-100%
			116		GREEN FINE - PIXEL 15
				0-255	16-bit FINE Adjustment
45	59	59	117		BLUE - PIXEL 15
				0-255	0-100%
			118		BLUE FINE - PIXEL 15
				0-255	16-bit FINE Adjustment
	60	60	119		AMBER - PIXEL 15
				0-256	0-100%
			120		AMBER FINE - PIXEL 15
				0-256	16-bit FINE Adjustment

**DYNAMIC AMBER AUTOMATICALLY ADDED TO RGB CHANNELS**

MODE / CHANNEL				VALUE	FUNCTION
48CH DA	64CH RGBA	72CH Pixel	128CH 16Bit		
46	61	61	121		RED - PIXEL 16
				0-255	0-100%
			122		RED FINE - PIXEL 16
				0-255	16-bit FINE Adjustment
47	62	62	123		GREEN - PIXEL 16
				0-255	0-100%
			124		GREEN FINE - PIXEL 16
				0-255	16-bit FINE Adjustment
48	63	63	125		BLUE - PIXEL 16
				0-255	0-100%
			126		BLUE FINE - PIXEL 16
				0-255	16-bit FINE Adjustment
	64	64	127		AMBER - PIXEL 16
				0-256	0-100%
			128		AMBER FINE - PIXEL 16
				0-256	16-bit FINE Adjustment
		65			PROGRAM MACROS
				0-19	NO FUNCTION
				1-20	PROGRAM 01
				21-40	PROGRAM 02
				41-60	PROGRAM 03
				62-80	PROGRAM 04
				81-100	PROGRAM 05
				101-120	PROGRAM 06
				121-140	PROGRAM 07
				141-160	PROGRAM 08
				161-180	PROGRAM 09
				181-200	PROGRAM 10
				201-220	PROGRAM 11
				221-240	PROGRAM 12
				241-250	PROGRAM 13
251-255	PROGRAM 14				
		66			PROGRAM MACRO SPEED
				0-255	Program Macro SPEED SLOW to FAST
		67			PROGRAM MACRO FADE
				0-255	Program Macro FADE SLOW to FAST

**DYNAMIC AMBER AUTOMATICALLY ADDED TO RGB CHANNELS**

MODE / CHANNEL				VALUE	FUNCTION
48CH DA	64CH RGBA	72CH Pixel	128CH 16Bit		
		68			<b>COLOR MACROS</b>
				1-4	Color Macro 01
				5-8	Color Macro 02
				9-12	Color Macro 03
				13-16	Color Macro 04
				17-20	Color Macro 05
				21-24	Color Macro 06
				25-28	Color Macro 07
				29-32	Color Macro 08
				33-36	Color Macro 09
				37-40	Color Macro 10
				41-44	Color Macro 11
				45-48	Color Macro 12
				49-52	Color Macro 13
				53-56	Color Macro 14
				57-60	Color Macro 15
				61-64	Color Macro 16
				65-68	Color Macro 17
				69-72	Color Macro 18
				73-76	Color Macro 19
				77-80	Color Macro 20
				81-84	Color Macro 21
				85-88	Color Macro 22
				89-92	Color Macro 23
				93-96	Color Macro 24
				97-100	Color Macro 25
				101-104	Color Macro 26
				105-108	Color Macro 27
				109-112	Color Macro 28
				113-116	Color Macro 29
				117-120	Color Macro 30
				121-124	Color Macro 31
				125-128	Color Macro 32
				129-132	Color Macro 33
				133-136	Color Macro 34
				137-140	Color Macro 35
				141-144	Color Macro 36
				145-148	Color Macro 37
				149-152	Color Macro 38



**DYNAMIC AMBER AUTOMATICALLY ADDED TO RGB CHANNELS**

MODE / CHANNEL				VALUE	FUNCTION
48CH DA	64CH RGBA	72CH Pixel	128CH 16Bit		
					<b>COLOR MACROS (continued)</b>
				153-156	Color Macro 39
				157-160	Color Macro 40
				161-164	Color Macro 41
				165-168	Color Macro 42
				169-172	Color Macro 43
				173-176	Color Macro 44
				177-180	Color Macro 45
				181-184	Color Macro 46
				185-188	Color Macro 47
				189-192	Color Macro 48
				193-196	Color Macro 49
				197-200	Color Macro 50
		68		201-204	Color Macro 51
				205-208	Color Macro 52
				209-212	Color Macro 53
				213-216	Color Macro 54
				217-220	Color Macro 55
				221-224	Color Macro 56
				225-228	Color Macro 57
				229-232	Color Macro 58
				233-236	Color Macro 59
				237-240	Color Macro 60
				241-244	Color Macro 61
				245-248	Color Macro 62
				249-252	Color Macro 63
				253-255	Color Macro 64
		69			<b>MASTER DIMMER / INTENSITY</b>
				0-255	Dimmer (0-100%)
		70			<b>MASTER DIMMER / INTENSITY FINE</b>
				0-255	Dimmer (0-100%)
					<b>SHUTTER / STROBE</b>
				0-31	LED OFF
				32-63	LED ON
				64-95	Strobe Effect SLOW to FAST
				96-127	LED ON
				128-159	Strobe Pulse Effect In Sequences SLOW to FAST
				160-191	LED ON
				192-223	Random Strobe Effect SLOW to FAST
				224-255	LED ON
					<b>DIMMING MODES</b>
				0-20	STANDARD
				21-40	STAGE
				41-60	TV
				61-80	ARCHITECTURAL
				81-100	THEATER
				101-120	STAGE 2
				121-255	DEFAULT TO UNIT SETTING
		71			
		72			

# TECHNICAL SPECIFICATIONS

## SOURCE

16 30W 4-in-1 RGBA COB LEDs

50,000 Hour Average LED Life\*

\*May vary depending on several factors including but not limited to:  
Environmental Conditions, Power/Voltage, Usage Patterns (On-Off Cycling), Control, and Dimming.

## EFFECTS

Full Pixel Control with Pixel Flip Modes

RGB + Dynamic Amber Channel Modes

Smooth Color Mixing and 64 Internal Color Macros

High Speed Electronic Shutter and Strobe

16Bit Dimming and Variable Dimming Curve Modes

## COLOR

RGBA

## CONTROL / CONNECTIONS

14 DMX Channel Modes (128 total channels)

Adjustable Refresh Rate (900-1500, 25,000 Hz)

Adjustable Gamma Brightness (2.0, 2.2, 2.4, 2.8)

4 Button Control Panel / OLED Menu Display

DMX, RDM, Kling-NET, and Art-NET Protocol Support

IP65 5pin DMX and RJ45 etherCON In/Out

IP65 Power In/Out

Fixture-to-Fixture Interlocking Alignment Pins/Locks

## SIZE / WEIGHT

Length: 17.3" (440mm)

Width: 8.1" (206mm)

Vertical Height: 17.3" (440mm)

Weight: 33.0 lbs. (15.0 kg)

## ELECTRICAL / THERMAL

AC 100-240V - 50/60Hz

520W Max Power Consumption

14°F to 113°F (-10°C to 45°C)

## APPROVALS / RATINGS

CE | IP65

Specifications and improvements in the design of this unit and this manual are subject to change without any prior written notice.

## **FCC STATEMENT**

This device complies with Part 15 of the FCC Rules. Operation is subject to the following two conditions: (1) this device may not cause harmful interference, and (2) this device must accept any interference received, including interference that may cause undesired operation.

## **FCC RADIO FREQUENCY INTERFERENCE WARNINGS & INSTRUCTIONS**

This product has been tested and found to comply with the limits as per Part 15 of the FCC Rules. These limits are designed to provide reasonable protection against harmful interference in a residential installation. This device uses and can radiate radio frequency energy and, if not installed and used in accordance with the included instructions, may cause harmful interference to radio communications. However, there is no guarantee that interference will not occur in a particular installation. If this device does cause harmful interference to radio or television reception, which can be determined by turning the device off and on, the user is encouraged to try to correct the interference by one or more of the following methods:

- Reorient or relocate the device.
- Increase the separation between the device and the receiver.
- Connect the device to an electrical outlet on a circuit different from which the radio receiver is connected.
- Consult the dealer or an experienced radio/TV technician for help.

# DIMENSIONAL DRAWINGS

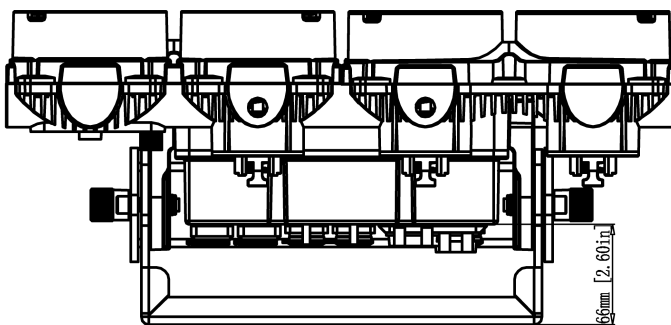
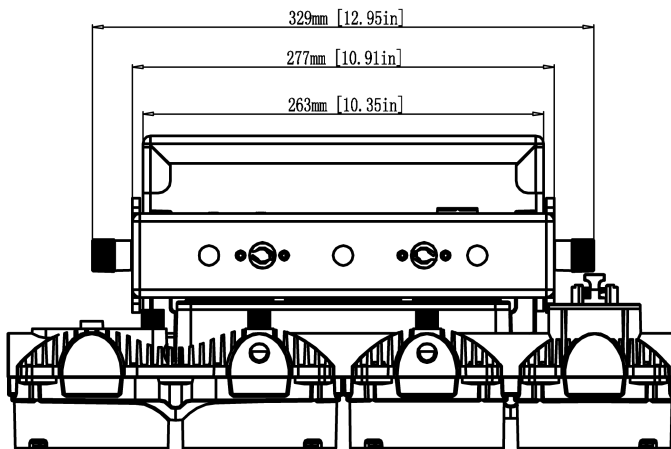
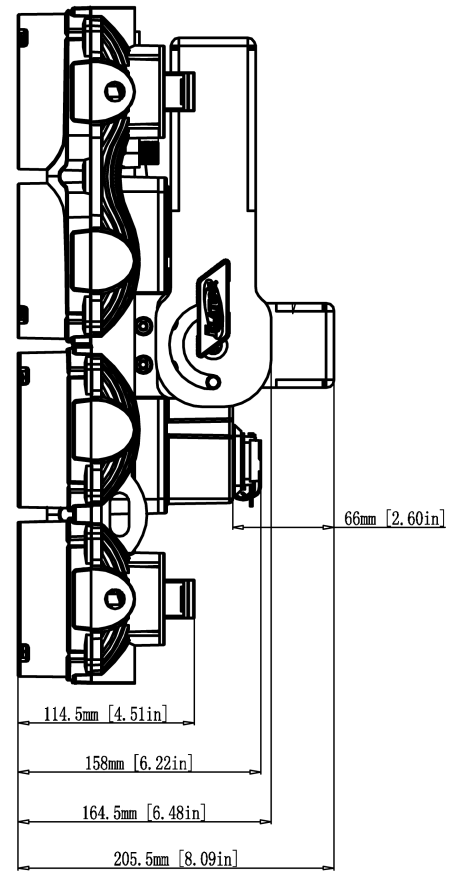
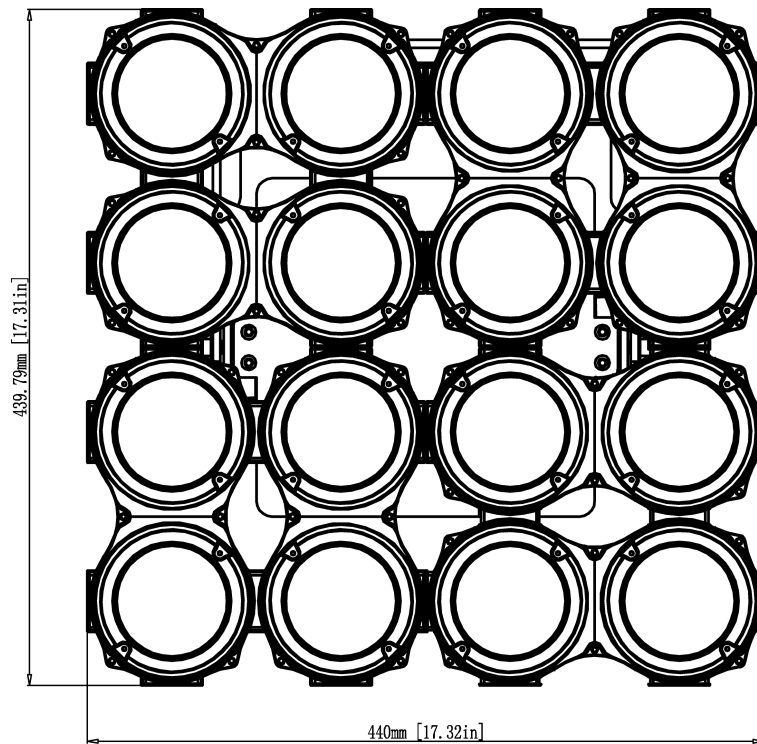

Specifications and improvements in the design of this unit and this manual are subject to change without any prior written notice.

## OPTIONAL ACCESSORIES

ORDER CODE	ITEM
TRIGGER CLAMP	Heavy Duty Wrap Around Hook Style Clamp
SCABLE60	Safety Cable 24" (610mm) 60 lbs. (27kg) Rating
8050000053	Omega Bracket 107mm
STR527	5 ft. (1.5m) IP65 5pin DMX Cable
NEU088	3 ft. (1m) powerCON TRUE1 Power Link Cable
	Additional Cable Lengths Available

