

SIXBAR 1000 IP™

user manual

©2016 **ELATION PROFESSIONAL** all rights reserved. Information, specifications, diagrams, images, and instructions herein are subject to change without notice. ELATION PROFESSIONAL logo and identifying product names and numbers herein are trademarks of ELATION PROFESSIONAL. Copyright protection claimed includes all forms and matters of copyrightable materials and information now allowed by statutory or judicial law or hereinafter granted. Product names used in this document may be trademarks or registered trademarks of their respective companies and are hereby acknowledged. All non-ELATION brands and product names are trademarks or registered trademarks of their respective companies.

ELATION PROFESSIONAL and all affiliated companies hereby disclaim any and all liabilities for property, equipment, building, and electrical damages, injuries to any persons, and direct or indirect economic loss associated with the use or reliance of any information contained within this document, and/or as a result of the improper, unsafe, insufficient and negligent assembly, installation, rigging, and operation of this product.

Elation Professional USA | 6122 S. Eastern Ave. | Los Angeles, CA. 90040
323-582-3322 | 323-832-9142 fax | www.elationlighting.com | info@elationlighting.com

Elation Professional B.V. | Junostraat 2 | 6468 EW Kerkrade, The Netherlands
+31 45 546 85 66 | +31 45 546 85 96 fax | www.elationlighting.eu | info@elationlighting.eu

DOCUMENT VERSION



Please check www.elationlighting.com for the latest revision/update of this manual.

Date	Document Version	Software Version	DMX Channel Modes	Notes
6/26/16	1	≥V1.03	6 / 7 / 11 / 13 / 36 / 72 / 75 / 79	Initial release.
7/13/16	2	≥V1.03	6 / 7 / 11 / 13 / 36 / 72 / 75 / 79	Added updated photometric data.
3/31/17	2.1	N/C	N/C	Updated part # for Omega Bracket.
09/15/20	2.2	V1.08	No Change	Updated primary/secondary

CONTENTS

General Information	4
Warranty	7
Safety Instructions	8
General Guidelines	9
Fixture Overview	10
Fixture Installation	11
Fixture Menu	13
DMX Channel Functions And Values	19
Cleaning and Maintenance	29
Technical Specifications	30
Optional Accessories	33

GENERAL INFORMATION

INTRODUCTION

Congratulations, you have just purchased one of the most innovative and reliable lighting fixtures on the market today! This fixture has been designed to perform reliably for years when the guidelines in this booklet are followed. Please read and understand the instructions in this manual carefully and thoroughly before attempting to operate this unit. These instructions contain important information regarding safety during use and maintenance.



IP65 RATED

An IP rated lighting fixture is one, which is commonly installed in outdoor environments and has been designed with an enclosure that effectively protects the ingress (entry) of external foreign objects such as dust and water. The **International Protection (IP)** rating system is commonly expressed as "IP" (Ingress Protection) followed by two numbers (i.e. IP65) where the numbers define the degree of protection. The first digit (Foreign Bodies Protection) indicates the extent of protection against particles entering the fixture and the second digit (Water Protection) indicates the extent of protection against water entering the fixture. An IP65 rated lighting fixture is one, which has been designed and tested to protect against the ingress of dust (6) and low-pressure water jets from any direction (5).



MARINE/COASTAL ENVIRONMENT INSTALLATIONS!

Please note although this fixture is IP rated, the fixture is **NOT** suitable for marine and/or coastal environment installations. Installing this fixture in a marine and/or coastal environment may cause corrosion and/or excessive wear to the interior and/or exterior components of the fixture. Damages and/or performance issues resulting from installation in a marine and/or coastal environment will void the manufacturer's warranty and will **NOT** be subject to any warranty claims and/or repairs.



Ensure **ALL** connections and end caps are properly sealed with a non-conductive dielectric grease (available at most electrical suppliers) to prevent water ingress/condensation and/or corrosion.



OPTIONAL CORROSION-RESISTANT COATING

Optional Corrosion-Resistant Coatings may be available for this fixture. Please consult your **Elation Professional** sales representative for details.

UNPACKING

Every fixture has been thoroughly tested and has been shipped in perfect operating condition. Carefully check the shipping carton for damage that may have occurred during shipping. If the carton appears to be damaged, carefully inspect your unit for damage and be sure all accessories necessary to operate the unit have arrived intact. In the event damage has been found or parts are missing, please contact our customer support team for further instructions. Please do not return this unit to your dealer without first contacting customer support at the number listed below. Please do not discard the shipping carton in the trash. Please recycle whenever possible.

BOX CONTENTS

- Power Cable
- Glare Shield
- (3) Glare Shield Holding Screws
- (2) Lens Filters
- Manual & Warranty Card

CUSTOMER SUPPORT

Elation Professional® provides a customer support line, to provide set up help and to answer any question should you encounter problems during your set up or initial operation. You may also visit us on the web at www.elationlighting.com for any comments or suggestions. For service related issue please contact Elation Professional®.

ELATION SERVICE USA - Monday - Friday 8:00am to 5:00pm PST

Voice: 323-582-3322

Fax: 323-832-9142

E-mail: support@elationlighting.com

ELATION SERVICE EUROPE - Monday - Friday 08:30 to 17:00 CET

Voice: +31 45 546 85 30

Fax: +31 45 546 85 96

E-mail: support@elationlighting.eu

WARRANTY REGISTRATION

Please complete and mail in the enclosed warranty card or register online: <http://www.elationlighting.com/Login.aspx> to validate your purchase. All returned service items whether under warranty or not, must be freight pre-paid and accompany a return authorization (R.A.) number. The R.A. number must be clearly written on the outside of the return package. A brief description of the problem as well as the R.A. number must also be written down on a piece of paper and included in the shipping container. If the unit is under warranty, you must provide a copy of your proof of purchase invoice. Items returned without a R.A. number clearly marked on the outside of the package will be refused and returned at customer's expense. You may obtain a R.A. number by contacting customer support.

IMPORTANT NOTICE!

There are no user serviceable parts inside this unit. Do not attempt any repairs yourself; doing so will void your manufactures warranty. Damages resulting from modifications to this fixture and/or the disregard of safety and general user instructions found in this user manual void the manufactures warranty and are not subject to any warranty claims and/or repairs.



RISK GROUP 3 - RISK OF EXPOSURE TO ULTRAVIOLET (UV) RADIATION!
FIXTURE EMITS HIGH INTENSITY WAVELENGTH OF ULTRAVIOLET LIGHT
WEAR PROPER EYE AND SKIN PROTECTION.
AVOID PROLONGED PERIODS OF EXPOSURE.
AVOID WEARING WHITE COLOR CLOTHING AND/OR USING (UV) PAINTS ON SKIN.

AVOID DIRECT EYE AND/OR SKIN EXPOSURE AT DISTANCES SHORTER THAN 11 feet (3.3m). DO NOT OPERATE FIXTURE WITH DAMAGED/MISSING EXTERNAL COVER PROTECTIVE LENS. DO NOT LOOK DIRECTLY INTO THE (UV) LIGHT AND/OR VIEW (UV) LIGHT DIRECTLY WITH OPTICAL INSTRUMENTS THAT MAY CONCENTRATE THE LIGHT/RADIATION OUTPUT. INDIVIDUALS SUFFERING FROM A RANGE OF EYE CONDITIONS, SUNLIGHT EXPOSURE DISORDERS, OR INDIVIDUALS USING PHOTSENSITIVE MEDICATION, MAY RECEIVE DISCOMFORT IF EXPOSED TO THE ULTRAVIOLET (UV) LIGHT EMITTED FROM THIS FIXTURE.

LIMITED WARRANTY

A. Elation Professional® hereby warrants, to the original purchaser, Elation Professional® products to be free of manufacturing defects in material and workmanship for a period of two years (730 days), and Elation Professional® product rechargeable batteries to be free of manufacturing defects in material and workmanship for a period of six months (180 days), from the original date of purchase. This warranty excludes discharge lamps and all product accessories. This warranty shall be valid only if the product is purchased within the United States of America, including possessions and territories. It is the owner's responsibility to establish the date and place of purchase by acceptable evidence, at the time service is sought.

B. For warranty service, send the product only to the Elation Professional® factory. All shipping charges must be pre-paid. If the requested repairs or service (including parts replacement) are within the terms of this warranty, Elation Professional® will pay return shipping charges only to a designated point within the United States. If any product is sent, it must be shipped in its original package and packaging material. No accessories should be shipped with the product. If any accessories are shipped with the product, Elation Professional® shall have no liability what so ever for loss and/or or damage to any such accessories, nor for the safe return thereof.

C. This warranty is void if the product serial number and/or labels are altered or removed; if the product is modified in any manner which Elation Professional® concludes, after inspection, affects the reliability of the product; if the product has been repaired or serviced by anyone other than the Elation Professional® factory unless prior written authorization was issued to purchaser by Elation Professional®; if the product is damaged because not properly maintained as set forth in the product instructions, guidelines and/or user manual.

D. This is not a service contract, and this warranty does not include any maintenance, cleaning or periodic check-up. During the periods as specified above, Elation Professional® will replace defective parts at its expense, and will absorb all expenses for warranty service and repair labor by reason of defects in material or workmanship. The sole responsibility of Elation Professional® under this warranty shall be limited to the repair of the product, or replacement thereof, including parts, at the sole discretion of Elation Professional®. All products covered by this warranty were manufactured after January 1, 1990, and PAR 200e identifying marks to that effect.

E. Elation Professional® reserves the right to make changes in design and/or performance improvements upon its products without any obligation to include these changes in any products theretofore manufactured.

F. No warranty, whether expressed or implied, is given or made with respect to any accessory supplied with the products described above. Except to the extent prohibited by applicable law, all implied warranties made by Elation Professional® in connection with this product, including warranties of merchantability or fitness, are limited in duration to the warranty periods set forth above. And no warranties, whether expressed or implied, including warranties of merchantability or fitness, shall apply to this product after said periods have expired. The consumer's and/or dealer's sole remedy shall be such repair or replacement as is expressly provided above; and under no circumstances shall Elation Professional® be liable for any loss and/or damage, direct and/or consequential, arising out of the use of, and/or the inability to use, this product.

G. This warranty is the only written warranty applicable to Elation Professional® products and supersedes all prior warranties and written descriptions of warranty terms and conditions heretofore published.

SAFETY INSTRUCTIONS



This fixture is an extremely sophisticated piece of electronic equipment. To guarantee a smooth operation, it is important to follow the guidelines in this manual. The manufacturer of this device will not accept responsibility for damages resulting from the misuse of this fixture due to the disregard of the information printed in this manual.



This device falls under **PROTECTION CLASS 1**. It's essential this device be grounded properly. Only qualified personnel should perform all electrical connections.



**UNPLUG POWER BEFORE SERVICING FIXTURE!
DO NOT PLUG FIXTURE INTO A DIMMER PACK!
NEVER TOUCH FIXTURE DURING OPERATION, AS IT MAY BE HOT!**



**NEVER LOOK DIRECTLY INTO THE LIGHT SOURCE!
SENSITIVE PERSONS MAY SUFFER AN EPILEPTIC SHOCK!**

- For proper operation, follow the **Installation** guidelines described in this manual. Only qualified and certified personnel should perform installation of this fixture and only the original rigging parts (brackets) included with this fixture should be used for installation. Any modifications will void the original manufacturer's warranty and increase the risk of damage and/or personal injury.
- Never look directly into the light source of this fixture to prevent risk of injury to your retina, which may induce blindness. Those suffering from **EPILEPSY** should avoid looking directly into the light source of this unit at all times.
- The fan and air inlets must remain clean and never blocked. Allow approx. 6" (15cm) between this fixture and other devices or a wall for proper cooling.
- Always disconnect from main power source before performing any type of service and/or cleaning procedure. Only handle the power cord by the plug end, never pull out the plug by tugging the wire portion of the cord.
- Do not operate this fixture if the power cord has become frayed, crimped and/or damaged. If the power cord is damaged, replace it immediately with a new one of similar power rating.

GENERAL GUIDELINES



- **NEVER OPEN THIS FIXTURE WHILE IN USE!**
- Ensure ALL connections and end caps are properly sealed with a dielectric grease (available at most electrical suppliers) to prevent water corrosion and/or electrical short circuit.
- During the initial operation of this fixture, a light smoke or smell may emit from the interior of the fixture. This is a normal process and is caused by excess paint in the interior of the casing burning off from the heat associated with the lamp and will decrease gradually over time.
- Please make sure there are **NO FLAMMABLE MATERIALS** close to the fixture while operating, to prevent any fire hazard.
- The fixture must be installed in a location with adequate ventilation, at least 1.5 feet (.5m) from adjacent surfaces. Be sure no air ventilation slots are blocked.
- **DO NOT** attempt installation and/or operation without knowledge how to do so.
- **DO NOT** permit operation by persons who are not qualified to operate this type of fixture. Most damages are the result of operations by nonprofessionals.
- Consistent operational breaks may ensure the fixture will function properly for many years to come.
- **DO NOT** shake fixture, avoid brute force when installing and/or operating fixture.
- Always install the fixture with an appropriate safety cable. When installing the fixture in a suspended environment, always use mounting hardware that is no less than M10 x 25 mm, also be sure the hardware is insert in the pre-arranged screw holes in the bracket of the fixture.
- Use the original packaging and materials to transport the fixture in for service.
- **DO NOT TOUCH** the housing bare-hand during its operation. Turn OFF the power and allow approximately 15 minutes for the fixture to cool down before replacing or serving.

FIXTURE OVERVIEW

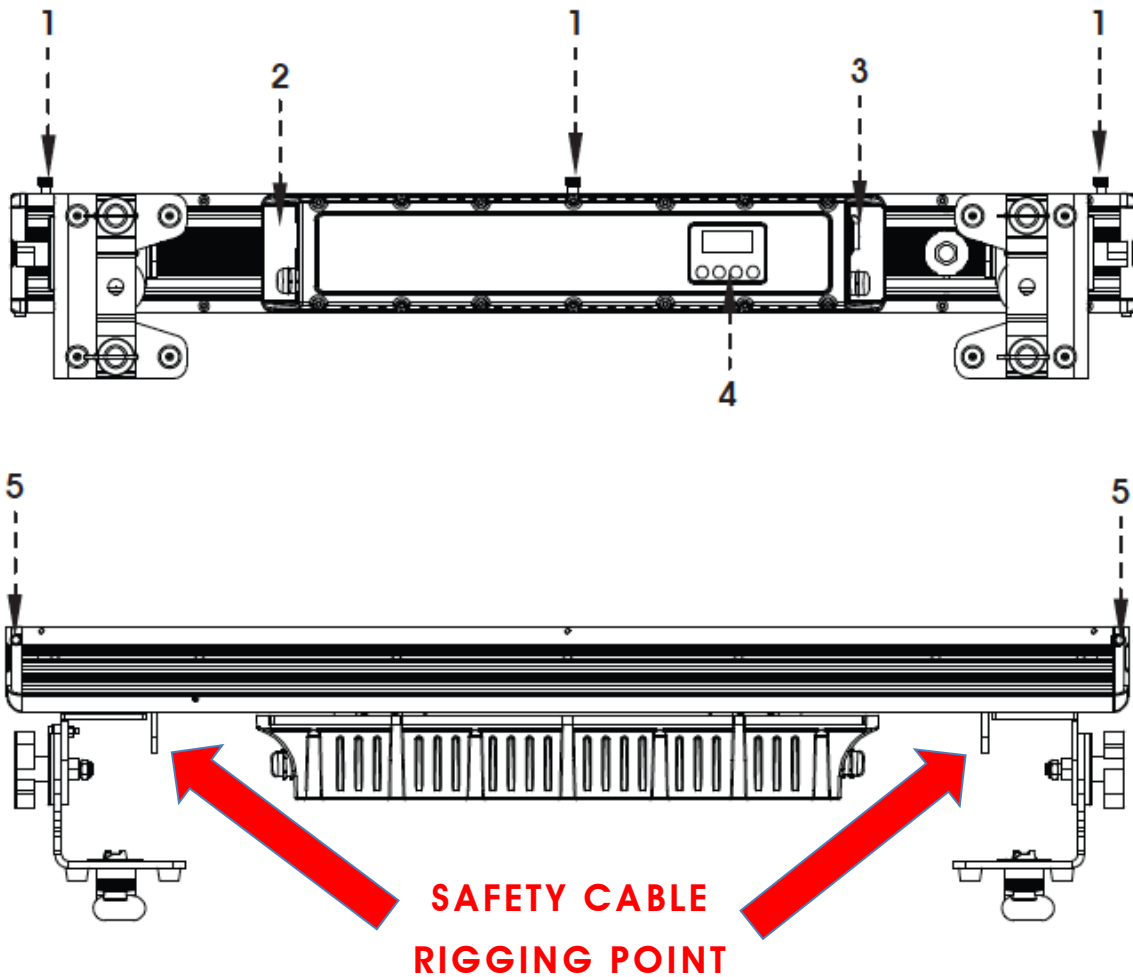

1. **Glare Shield Holding Screws (x3)**
2. **IP Rated Power and DMX INPUTS**
3. **IP Rated Power and DMX OUTPUTS**
4. **LCD Menu Control Display, and MENU, UP, DOWN, ENTER Buttons**
5. **Frost Filter Lens Release Button**

FIXTURE INSTALLATION



FLAMMABLE MATERIAL WARNING

Keep fixture at least 5.0 ft (1.5m) away from any flammable materials, decorations, pyrotechnics, etc.



ELECTRICAL CONNECTIONS

A qualified electrician should be used for all electrical connections and/or installations.

CAUTIONS

- For added protection, mount the fixture in areas outside walking paths, seating areas, or in areas where unauthorized personnel might reach the fixture.
- Ambient operating temperature range for this fixture is **5° to 113°F. (-15° to 45°C)**
Do not use the fixture under or above this temperature.
- Before mounting the fixture to any surface, make sure the installation area can hold a minimum point load of 10 times the weight of the fixture.
- Fixture installation must always be secured with a secondary safety attachment, such as an appropriate safety cable.
- Never stand directly below the device when mounting, removing or servicing.



- **Ensure ALL connections and end caps are properly sealed with a dielectric grease (available at most electrical suppliers) to prevent water corrosion and/or electrical short circuit.**

POWER LINKING

Max number of units that can be power linked is **6 units @110V** and **14 units @240V**.

CLAMP MOUNTING

The fixture provides an integrated mounting dual bracket / yoke. Make sure to secure an appropriately rated clamp to the mounting bracket using M10 screws when mounting this fixture to truss.

MOUNTING POINTS

Overhead mounting requires extensive experience, including amongst others calculating working load limits, installation material being used, and periodic safety inspection of all installation material and the device. If you lack these qualifications, do not attempt the installation yourself. Improper installation can result in bodily injury. Fixture is fully operational in the specific mounting positions as illustrated below.

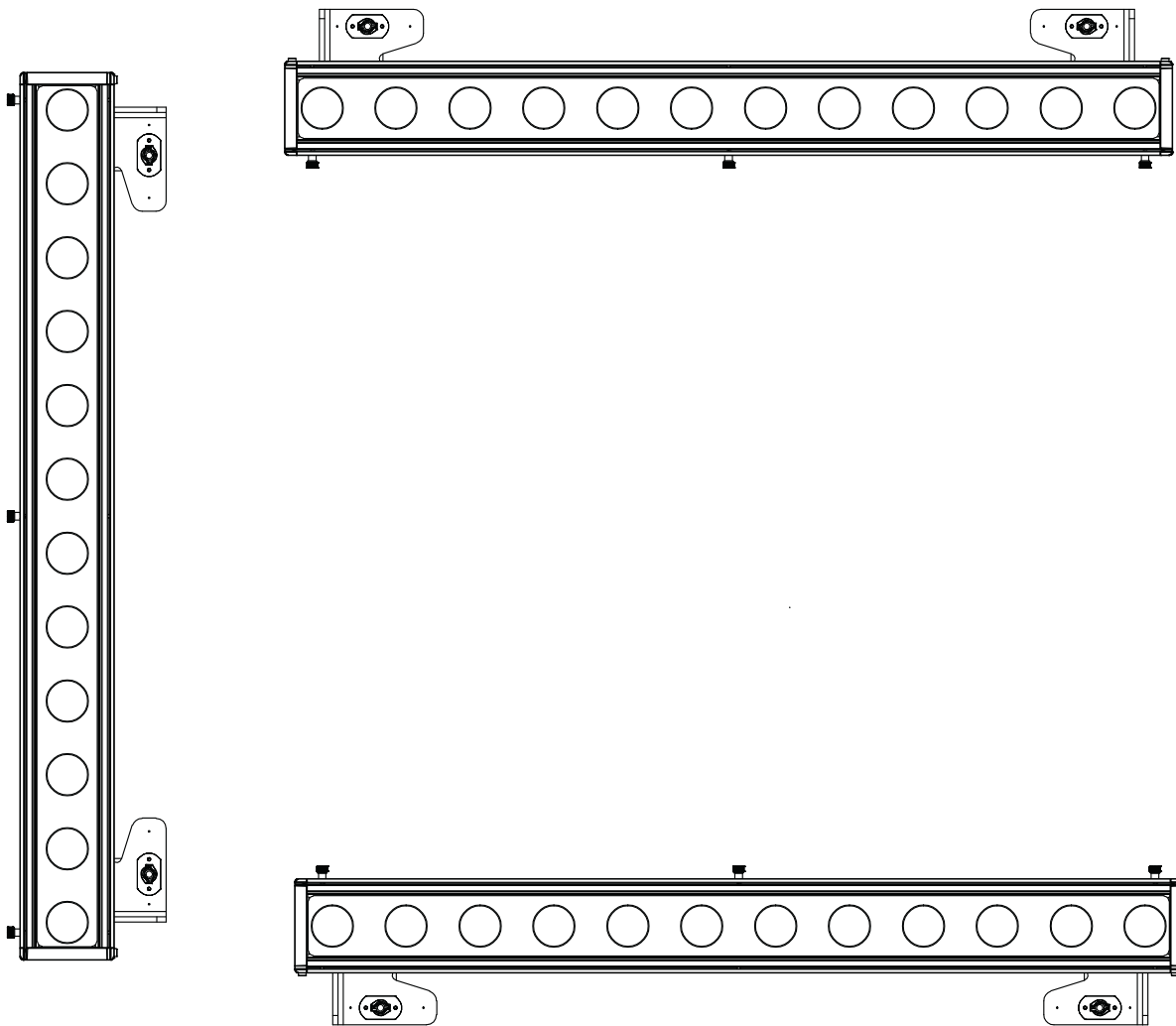

SAFETY CABLES

ALWAYS USE A SAFETY CABLE (NOT INCLUDED) WHENEVER INSTALLING THIS FIXTURE IN A SUSPENDED ENVIRONMENT TO ENSURE THE FIXTURE WILL NOT DROP IF THE CLAMP FAILS.

FIXTURE MENU

ON-BOARD SYSTEM MENU

The fixture comes with an easy to navigate system menu. The next section will detail the functions of each command in the system menu.

LCD MENU CONTROL PANEL

The control panel (see image below) located on back of the fixture allows you to access the main menu and make all necessary adjustments to the fixture. During normal operation, pressing **MODE** button once will access the fixture's main menu. Once in the main menu you can navigate through the different functions and access the sub-menus with the **UP** and **DOWN** buttons. Once you reach a field that requires adjusting, press the **ENTER** button to activate that field and use the **UP** and **DOWN** buttons to adjust the field. Pressing the **ENTER** button once more will confirm your setting. You may exit the main menu at any time without making any adjustments by pressing the **MODE** button.



INFORMATION DISPLAYED DURING INITIAL POWER ON

When the fixture is initially powered ON, the display shows the following information:



LCD CONTROL PANEL LOCKOUT

When **AutoLock** menu is set to **ON**, the LCD display backlight will turn OFF after 30 seconds and the Control Panel will lock and the display will show **LOCKED*******. Press and hold the **MODE** button for 5 seconds to unlock.

When **AutoLock** menu is set to **ON1**, the LCD display backlight will turn OFF after 30 seconds and the Control Panel will lock and the display will show **LOCKED*******.

To unlock the Control Panel follow these steps:

1. When locked, the display will show: **LOCKED*******
2. Press **UP**, then the display will change to: **LOCKED****** (one * disappears)
3. Press **DOWN**, then the display will change to: **LOCKED***** (two * disappear)
4. Press **UP**, then the display will change to: **LOCKED**** (three * disappear)
5. Press **DOWN**, then the display will change to: **LOCKED*** (4 * disappear)
6. Press **ENTER**, then the display will change to **LOCKED** and then become unlocked.

ELATION© SIXBAR 1000 IP™ SYSTEM MENU		
Specifications are subject to change without any prior written notice.		
MENU	OPTIONS / VALUES (Default Settings BOLD)	DESCRIPTION
DMX MODE ADDR:xxx CH:xx	ADDR: 001 - 512 CH: 06 , 07, 11, 13, 36, 72, 75, 79	Set DMX Address. Set DMX Channel Mode.
SECONDRY M O D E	Secondary	Set unit to Secondary Mode.
AUTO RUN FQN:xx	FQN: 01 -99	Set the number of times each internal macro will repeat before moving to the next macro.
01.STATIC - 15.FLOW1	01 -15	Select Internal Program Macro. See PROGRAM MACRO MENU for more details.
DimCurve	Standard , Stage, TV, Architec, Theatre	Set desired Dimming Curve.
Flip	ON, OFF	Set starting LED. See FLIP Section for more details.
NO DMX	Hold , Blackout, Program	Define how fixture reacts when NO DMX signal present.
Manual	R000 -255 G000 -255 B000 -255 W000 -255 A000 -255 U000 -255 STR: 00 -99	Set RGBWAU and Strobe Values manually.
Macros	00 -63	Select Internal Color Macro. See COLOR MACRO MENU for more details.
AutoLock	OFF (default) , ON, ON1	Set LCD Control Panel Lockout Function.
Temp.	000	Fixture Internal Temperature (Celsius).

ELATION© SIXBAR 1000 IP™

P R G R A M M A C R O M E N U

Features are subject to change without any prior written notice.

MACRO	OPTIONS / VALUES	DESCRIPTION
01.STATIC	CL:RGBF00-99	
02.DREAM	Speed01-99Flash00-99	
03.METOR	Speed01-99Flash00-99	
04.FADE	Speed01-99Flash00-99	
05.CHANG	Speed01-99Flash00-99	
06.FLOW1	Speed01-99Flash00-99	
07.FLOW2	Speed01-99Flash00-99	
08.FLOW3	Speed01-99Flash00-99	
09.FLOW4	Speed01-99Flash00-99	
10.FLOW5	Speed01-99Flash00-99	
11.FLOW6	Speed01-99Flash00-99	
12.FLOW7	Speed01-99Flash00-99	
13.FLOW8	Speed01-99Flash00-99 C1:RGBC2:RGB	
14.FLOW 9	Speed01-99Flash00-99 C1:RGBC2:RGB	
15.FLOW 10	Speed01-99Flash00-99	

DimCurve

Select desired DIMMER MODE (**Standard**, Stage, TV, Architec, Theatre).

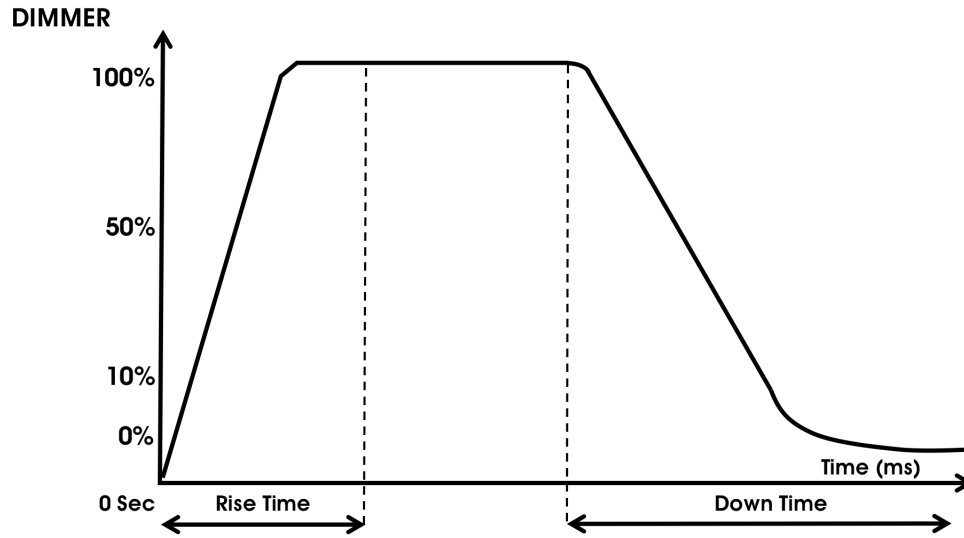

Dimming Curve Ramp Effect	0 sec Fade Time		1 sec Fade Time	
	Rise Time (ms)	Down Time (ms)	Rise Time (ms)	Down Time (ms)
Standard (default)	0	0	0	0
Stage	780	1100	1540	1660
TV	1180	1520	1860	1940
Architectural	1380	1730	2040	2120
Theatre	1580	1940	2230	2280

Flip



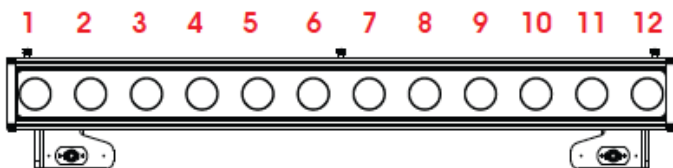



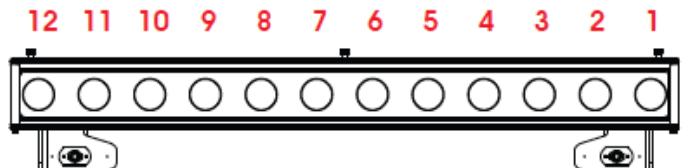







Select the desired starting LED and chase direction from one of the following modes below via **UP/DOWN** buttons and then press **ENTER** to confirm. (**Default = STANDARD**)





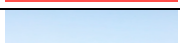









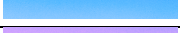

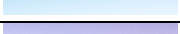
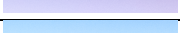
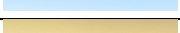

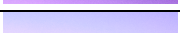

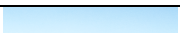

FLIP = OFF



FLIP = ON

ELATION© SIXBAR 1000 IP™ C O L O R M A C R O M E N U			
Actual colors may vary and subject to change without notice.			
MACRO #	COLOR MACRO		DMX VALUES
00	OFF		0-3
01	RED		4-7
02	GREEN		8-11
03	BLUE		12-15
04	WHITE		16-19
05	AMBER		20-23
06	UV		24-27
07	RED + GREEN		28-31
08	RED + BLUE		32-35
09	RED + WHITE		36-39
10	RED + AMBER		40-43
11	RED + UV		44-47
12	GREEN + BLUE		48-51
13	GREEN + WHITE		52-55
14	GREEN+ AMBER		56-59
15	GREEN + UV		60-63
16	BLUE + WHITE		64-67
17	BLUE + AMBER		68-71
18	BLUE + UV		72-75
19	WHITE + AMBER		76-79
20	WHITE + UV		80-83
21	AMBER + UV		84-87
22	RED + GREEN + BLUE		88-91
23	RED + GREEN + WHITE		92-95
24	RED + GREEN + AMBER		96-99
25	RED + GREEN + UV		100-103
26	RED + BLUE + WHITE		104-107
27	RED + BLUE + AMBER		108-111
28	RED + BLUE + UV		112-115
29	RED + WHITE + AMBER		116-119
30	RED + WHITE + UV		120-123
31	RED + AMBER + UV		124-127
32	GREEN + BLUE + WHITE		128-131

ELATION© SIXBAR 1000 IP™ C O L O R M A C R O M E N U			
Actual colors may vary and subject to change without notice.			
MACRO #	COLOR MACRO		DMX VALUES
33	GREEN + BLUE + AMBER		132-135
34	GREEN + BLUE + UV		136-139
35	GREEN + WHITE + AMBER		140-143
36	GREEN + WHITE + UV		144-147
37	GREEN + AMBER + UV		148-151
38	BLUE + WHITE + AMBER		152-155
39	BLUE + WHITE + UV		156-159
40	BLUE + AMBER + UV		160-163
41	WHITE + AMBER + UV		164-167
42	RED + GREEN + BLUE + WHITE		168-171
43	RED + GREEN + BLUE + WHITE		172-175
44	RED + GREEN + BLUE + UV		176-179
45	RED + GREEN + WHITE + AMBER		180-183
46	RED + GREEN + WHITE + UV		184-187
47	RED + GREEN + AMBER + UV		188-191
48	RED + BLUE + WHITE + AMBER		192-195
49	RED + BLUE + WHITE + UV		196-199
50	RED + BLUE + AMBER + UV		200-203
51	RED + WHITE + AMBER + UV		204-207
52	GREEN + BLUE + WHITE + AMBER		208-211
53	GREEN + BLUE + WHITE + UV		212-215
54	GREEN + BLUE + AMBER + UV		216-219
55	GREEN + WHITE + AMBER + UV		220-223
56	BLUE + WHITE + AMBER + UV		224-227
57	RED + GREEN + BLUE + WHITE + AMBER		228-231
58	RED + GREEN + BLUE + WHITE + UV		232-235
59	RED + GREEN + BLUE + AMBER + UV		236-239
60	RED + GREEN + WHITE + AMBER + UV		240-243
61	RED + BLUE + WHITE + AMBER + UV		244-247
62	GREEN + BLUE + WHITE + AMBER + UV		248-251
63	RED + GREEN + BLUE + WHITE + AMBER + UV		252-255

DMX CHANNEL FUNCTIONS AND VALUES

ELATION© SIXBAR 1000 IP™									
DMX Channel Values / Functions Version 1 (79 DMX Channels)									
Features are subject to change without any prior written notice. *Control of LEDs depends on the Pixel Flip setting.									
DMX CHANNEL MODE								VALUE	FUNCTION
6CH	7CH	11CH	13CH	36CH	72CH	75CH	79CH		
1	1	1	1					0-255	RED LED - All LEDs [1-12] Red (0-Black - 255-100%)
2	2	2	2					0-255	GREEN LED - All LEDs [1-12] Green (0-Black - 255-100%)
3	3	3	3					0-255	BLUE LED - All LEDs [1-12] Blue (0-Black - 255-100%)
4	4	4	4					0-255	WHITE LED - All LEDs [1-12] White (0-Black - 255-100%)
5	5	5	5					0-255	AMBER LED - All LEDs [1-12] Amber (0-Black - 255-100%)
6	6	6	6					0-255	UV LED - All LEDs [1-12] UV (0-Black - 255-100%)
				1				0-255	RED LED - All LEDs [1-2] Red (0-Black - 255-100%)
				2				0-255	GREEN LED - All LEDs [1-2] Green (0-Black - 255-100%)
				3				0-255	BLUE LED - All LEDs [1-2] Blue (0-Black - 255-100%)
				4				0-255	WHITE LED - All LEDs [1-2] White (0-Black - 255-100%)
				5				0-255	AMBER LED - All LEDs [1-2] Amber (0-Black - 255-100%)
				6				0-255	UV LED - All LEDs [1-2] UV (0-Black - 255-100%)
				7				0-255	RED LED - All LEDs [3-4] Red (0-Black - 255-100%)
				8				0-255	GREEN LED - All LEDs [3-4] Green (0-Black - 255-100%)
				9				0-255	BLUE LED - All LEDs [3-4] Blue (0-Black - 255-100%)
				10				0-255	WHITE LED - All LEDs [3-4] White (0-Black - 255-100%)
				11				0-255	AMBER LED - All LEDs [3-4] Amber (0-Black - 255-100%)
				12				0-255	UV LED - All LEDs [3-4] UV (0-Black - 255-100%)

ELATION© SIXBAR 1000 IP™									
DMX Channel Values / Functions Version 1 (79 DMX Channels)									
Features are subject to change without any prior written notice.									
*Control of LEDs depends on the Pixel Flip setting.									
DMX CHANNEL MODE									
6CH	7CH	11CH	13CH	36CH	72CH	75CH	79CH	VALUE	FUNCTION
				13					RED LED - All LEDs [5-6]
								0-255	Red (0-Black - 255-100%)
				14					GREEN LED - All LEDs [5-6]
								0-255	Green (0-Black - 255-100%)
				15					BLUE LED - All LEDs [5-6]
								0-255	Blue (0-Black - 255-100%)
				16					WHITE LED - All LEDs [5-6]
								0-255	White (0-Black - 255-100%)
				17					AMBER LED - All LEDs [5-6]
								0-255	Amber (0-Black - 255-100%)
				18					UV LED - All LEDs [5-6]
								0-255	UV (0-Black - 255-100%)
				19					RED LED - All LEDs [7-8]
								0-255	Red (0-Black - 255-100%)
				20					GREEN LED - All LEDs [7-8]
								0-255	Green (0-Black - 255-100%)
				21					BLUE LED - All LEDs [7-8]
								0-255	Blue (0-Black - 255-100%)
				22					WHITE LED - All LEDs [7-8]
								0-255	White (0-Black - 255-100%)
				23					AMBER LED - All LEDs [7-8]
								0-255	Amber (0-Black - 255-100%)
				24					UV LED - All LEDs [7-8]
								0-255	UV (0-Black - 255-100%)
				25					RED LED - All LEDs [9-10]
								0-255	Red (0-Black - 255-100%)
				26					GREEN LED - All LEDs [9-10]
								0-255	Green (0-Black - 255-100%)
				27					BLUE LED - All LEDs [9-10]
								0-255	Blue (0-Black - 255-100%)
				28					WHITE LED - All LEDs [9-10]
								0-255	White (0-Black - 255-100%)
				29					AMBER LED - All LEDs [9-10]
								0-255	Amber (0-Black - 255-100%)
				30					UV LED - All LEDs [9-10]
								0-255	UV (0-Black - 255-100%)

ELATION© SIXBAR 1000 IP™								VALUE	FUNCTION
DMX Channel Values / Functions Version 1 (79 DMX Channels)									
Features are subject to change without any prior written notice.									
*Control of LEDs depends on the Pixel Flip setting.									
DMX CHANNEL MODE								VALUE	FUNCTION
6CH	7CH	11CH	13CH	36CH	72CH	75CH	79CH		
				31					RED LED - All LEDs [11-12]
								0-255	Red (0-Black - 255-100%)
				32					GREEN LED - All LEDs [11-12]
								0-255	Green (0-Black - 255-100%)
				33					BLUE LED - All LEDs [11-12]
								0-255	Blue (0-Black - 255-100%)
				34					WHITE LED - All LEDs [11-12]
								0-255	White (0-Black - 255-100%)
				35					AMBER LED - All LEDs [11-12]
								0-255	Amber (0-Black - 255-100%)
				36					UV LED - All LEDs [11-12]
								0-255	UV (0-Black - 255-100%)
					1	1	1		RED LED - LED [1]
								0-255	Red (0-Black - 255-100%)
					2	2	2		GREEN LED - LED [1]
								0-255	Green (0-Black - 255-100%)
					3	3	3		BLUE LED - LED [1]
								0-255	Blue (0-Black - 255-100%)
					4	4	4		WHITE LED - LED [1]
								0-255	White (0-Black - 255-100%)
					5	5	5		AMBER LED - LED [1]
								0-255	Amber (0-Black - 255-100%)
					6	6	6		UV LED - LED [1]
								0-255	UV (0-Black - 255-100%)
					7	7	7		RED LED - LED [2]
								0-255	Red (0-Black - 255-100%)
					8	8	8		GREEN LED - LED [2]
								0-255	Green (0-Black - 255-100%)
					9	9	9		BLUE LED - LED [2]
								0-255	Blue (0-Black - 255-100%)
					10	10	10		WHITE LED - LED [2]
								0-255	White (0-Black - 255-100%)
					11	11	11		AMBER LED - LED [2]
								0-255	Amber (0-Black - 255-100%)

ELATION© SIXBAR 1000 IP™								VALUE	FUNCTION
DMX CHANNEL MODE									
6CH	7CH	11CH	13CH	36CH	72CH	75CH	79CH		
					12	12	12		UV LED - LED [2]
								0-255	UV (0-Black - 255-100%)
					13	13	13		RED LED - LED [3]
								0-255	Red (0-Black - 255-100%)
					14	14	14		GREEN LED - LED [3]
								0-255	Green (0-Black - 255-100%)
					15	15	15		BLUE LED - LED [3]
								0-255	Blue (0-Black - 255-100%)
					16	16	16		WHITE LED - LED [3]
								0-255	White (0-Black - 255-100%)
					17	17	17		AMBER LED - LED [3]
								0-255	Amber (0-Black - 255-100%)
					18	18	18		UV LED - LED [3]
								0-255	UV (0-Black - 255-100%)
					19	19	19		RED LED - LED [4]
								0-255	Red (0-Black - 255-100%)
					20	20	20		GREEN LED - LED [4]
								0-255	Green (0-Black - 255-100%)
					21	21	21		BLUE LED - LED [4]
								0-255	Blue (0-Black - 255-100%)
					22	22	22		WHITE LED - LED [4]
								0-255	White (0-Black - 255-100%)
					23	23	23		AMBER LED - LED [4]
								0-255	Amber (0-Black - 255-100%)
					24	24	24		UV LED - LED [4]
								0-255	UV (0-Black - 255-100%)
					25	25	25		RED LED - LED [5]
								0-255	Red (0-Black - 255-100%)
					26	26	26		GREEN LED - LED [5]
								0-255	Green (0-Black - 255-100%)
					27	27	27		BLUE LED - LED [5]
								0-255	Blue (0-Black - 255-100%)
					28	28	28		WHITE LED - LED [5]
								0-255	White (0-Black - 255-100%)
					29	29	29		AMBER LED - LED [5]
								0-255	Amber (0-Black - 255-100%)
					30	30	30		UV LED - LED [5]
								0-255	UV (0-Black - 255-100%)

ELATION© SIXBAR 1000 IP™								VALUE	FUNCTION
DMX Channel Values / Functions Version 1 (79 DMX Channels)									
Features are subject to change without any prior written notice.									
*Control of LEDs depends on the Pixel Flip setting.									
DMX CHANNEL MODE								VALUE	FUNCTION
6CH	7CH	11CH	13CH	36CH	72CH	75CH	79CH		
					31	31	31		RED LED - LED [6]
								0-255	Red (0-Black - 255-100%)
					32	32	32		GREEN LED - LED [6]
								0-255	Green (0-Black - 255-100%)
					33	33	33		BLUE LED - LED [6]
								0-255	Blue (0-Black - 255-100%)
					34	34	34		WHITE LED - LED [6]
								0-255	White (0-Black - 255-100%)
					35	35	35		AMBER LED - LED [6]
								0-255	Amber (0-Black - 255-100%)
					36	36	36		UV LED - LED [6]
								0-255	UV (0-Black - 255-100%)
					37	37	37		RED LED - LED [7]
								0-255	Red (0-Black - 255-100%)
					38	38	38		GREEN LED - LED [7]
								0-255	Green (0-Black - 255-100%)
					39	39	39		BLUE LED - LED [7]
								0-255	Blue (0-Black - 255-100%)
					40	40	40		WHITE LED - LED [7]
								0-255	White (0-Black - 255-100%)
					41	41	41		AMBER LED - LED [7]
								0-255	Amber (0-Black - 255-100%)
					42	42	42		UV LED - LED [7]
								0-255	UV (0-Black - 255-100%)
					43	43	43		RED LED - LED [8]
								0-255	Red (0-Black - 255-100%)
					44	44	44		GREEN LED - LED [8]
								0-255	Green (0-Black - 255-100%)
					45	45	45		BLUE LED - LED [8]
								0-255	Blue (0-Black - 255-100%)
					46	46	46		WHITE LED - LED [8]
								0-255	White (0-Black - 255-100%)
					47	47	47		AMBER LED - LED [8]
								0-255	Amber (0-Black - 255-100%)
					48	48	48		UV LED - LED [8]
								0-255	UV (0-Black - 255-100%)

ELATION© SIXBAR 1000 IP™									
DMX Channel Values / Functions Version 1 (79 DMX Channels)									
Features are subject to change without any prior written notice.									
*Control of LEDs depends on the Pixel Flip setting.									
DMX CHANNEL MODE								VALUE	FUNCTION
6CH	7CH	11CH	13CH	36CH	72CH	75CH	79CH		
					49	49	49		RED LED - LED [9]
								0-255	Red (0-Black - 255-100%)
					50	50	50		GREEN LED - LED [9]
								0-255	Green (0-Black - 255-100%)
					51	51	51		BLUE LED - LED [9]
								0-255	Blue (0-Black - 255-100%)
					52	52	52		WHITE LED - LED [9]
								0-255	White (0-Black - 255-100%)
					53	53	53		AMBER LED - LED [9]
								0-255	Amber (0-Black - 255-100%)
					54	54	54		UV LED - LED [9]
								0-255	UV (0-Black - 255-100%)
					55	55	55		RED LED - LED [10]
								0-255	Red (0-Black - 255-100%)
					56	56	56		GREEN LED - LED [10]
								0-255	Green (0-Black - 255-100%)
					57	57	57		BLUE LED - LED [10]
								0-255	Blue (0-Black - 255-100%)
					58	58	58		WHITE LED - LED [10]
								0-255	White (0-Black - 255-100%)
					59	59	59		AMBER LED - LED [10]
								0-255	Amber (0-Black - 255-100%)
					60	60	60		UV LED - LED [10]
								0-255	UV (0-Black - 255-100%)
					61	61	61		RED LED - LED [11]
								0-255	Red (0-Black - 255-100%)
					62	62	62		GREEN LED - LED [11]
								0-255	Green (0-Black - 255-100%)
					63	63	63		BLUE LED - LED [11]
								0-255	Blue (0-Black - 255-100%)
					64	64	64		WHITE LED - LED [11]
								0-255	White (0-Black - 255-100%)
					65	65	65		AMBER LED - LED [11]
								0-255	Amber (0-Black - 255-100%)
					66	66	66		UV LED - LED [11]
								0-255	UV (0-Black - 255-100%)

ELATION© SIXBAR 1000 IP™								VALUE	FUNCTION
DMX Channel Values / Functions Version 1 (79 DMX Channels)									
Features are subject to change without any prior written notice. *Control of LEDs depends on the Pixel Flip setting.									
DMX CHANNEL MODE								VALUE	FUNCTION
6CH	7CH	11CH	13CH	36CH	72CH	75CH	79CH		
					67	67	67	0-255	RED LED - LED [12] Red (0-Black - 255-100%)
					68	68	68	0-255	GREEN LED - LED [12] Green (0-Black - 255-100%)
					69	69	69	0-255	BLUE LED - LED [12] Blue (0-Black - 255-100%)
					70	70	70	0-255	WHITE LED - LED [12] White (0-Black - 255-100%)
					71	71	71	0-255	AMBER LED - LED [12] Amber (0-Black - 255-100%)
					72	72	72	0-255	UV LED - LED [12] UV (0-Black - 255-100%)
	7	7	7			73	73	0-255	MASTER DIMMER 0 to 100%
		8	8			74	74	0-31	STROBE NO Function
								32-63	LEDs ON
								64-95	Strobe Effect SLOW to FAST
								96-127	LEDs ON
								128-159	Pulse Effect In Sequence SLOW to FAST
								160-191	LEDs ON
								192-223	Random Strobe Effect SLOW to FAST
								224-255	LEDs ON

ELATION© SIXBAR 1000 IP™									
DMX Channel Values / Functions Version 1 (79 DMX Channels)									
Features are subject to change without any prior written notice.									
*Control of LEDs depends on the Pixel Flip setting.									
DMX CHANNEL MODE								VALUE	FUNCTION
6CH	7CH	11CH	13CH	36CH	72CH	75CH	79CH		
									COLOR MACROS
								0-3	NO Function
								4-7	Color Macro 01
								8-11	Color Macro 02
								12-15	Color Macro 03
								16-19	Color Macro 04
								20-23	Color Macro 05
								24-27	Color Macro 06
								28-31	Color Macro 07
								32-35	Color Macro 08
								36-39	Color Macro 09
								40-43	Color Macro 10
								44-47	Color Macro 11
								48-51	Color Macro 12
								52-55	Color Macro 13
								56-59	Color Macro 14
			9					60-63	Color Macro 15
								64-67	Color Macro 16
								68-71	Color Macro 17
								72-75	Color Macro 18
								76-79	Color Macro 19
								80-83	Color Macro 20
								84-87	Color Macro 21
								88-91	Color Macro 22
								92-95	Color Macro 23
								96-99	Color Macro 24
								100-103	Color Macro 25
								104-107	Color Macro 26
								108-111	Color Macro 27
								112-115	Color Macro 28
								116-119	Color Macro 29
								120-123	Color Macro 30
								124-127	Color Macro 31
								128-131	Color Macro 32

ELATION© SIXBAR 1000 IP™									
DMX Channel Values / Functions Version 1 (79 DMX Channels)									
Specifications are subject to change without any prior written notice.									
<i>*Control of LEDs depends on the Pixel Flip setting.</i>									
DMX CHANNEL MODE								VALUE	FUNCTION
6CH	7CH	11CH	13CH	36CH	72CH	75CH	79CH		
								132-135	Color Macro 33
								136-139	Color Macro 34
								140-143	Color Macro 35
								144-147	Color Macro 36
								148-151	Color Macro 37
								152-155	Color Macro 38
								156-159	Color Macro 39
								160-163	Color Macro 40
								164-167	Color Macro 41
								168-171	Color Macro 42
								172-175	Color Macro 43
								176-179	Color Macro 44
								180-183	Color Macro 45
								184-187	Color Macro 46
								188-191	Color Macro 47
			9				75	192-195	Color Macro 48
								196-199	Color Macro 49
								200-203	Color Macro 50
								204-207	Color Macro 51
								208-211	Color Macro 52
								212-215	Color Macro 53
								216-219	Color Macro 54
								220-223	Color Macro 55
								224-227	Color Macro 56
								228-231	Color Macro 57
								232-235	Color Macro 58
								236-239	Color Macro 59
								240-243	Color Macro 60
								244-247	Color Macro 61
								248-251	Color Macro 62
								252-255	Color Macro 63

ELATION© SIXBAR 1000 IP™									
DMX Channel Values / Functions Version 1 (79 DMX Channels)									
Specifications are subject to change without any prior written notice.									
*Control of LEDs depends on the Pixel Flip setting.									
DMX CHANNEL MODE								VALUE	FUNCTION
6CH	7CH	11CH	13CH	36CH	72CH	75CH	79CH		
		9	10				76		PROGRAM MACROS
								0-10	NO Function
								11-26	Program 01 - DREAM
								27-43	Program 02 - METEOR
								44-60	Program 03 - FADE
								61-76	Program 04 - CHANGE
								77-93	Program 05 - FLOW 1
								94-110	Program 06 - FLOW 2
								111-126	Program 07 - FLOW 3
								127-143	Program 08 - FLOW 4
								144-160	Program 09 - FLOW 5
								161-176	Program 10 - FLOW 6
								177-193	Program 11 - FLOW 7
								194-210	Program 12 - FLOW 8
								211-226	Program 13 - FLOW 9
								227-255	NO Function
		10	11				77		PROGRAM SPEED
								0-255	Program Speed SLOW to FAST
		11	12				78		PROGRAM FADE
								0-255	Program Fade FAST to SLOW
			13			75	79		DIMMING CURVE MODES
								0-20	STANDARD
								21-40	STAGE
								41-60	TV
								61-80	ARCHITECTURAL
								81-100	THEATRE
								101-255	Default to Unit Setting

CLEANING AND MAINTENANCE



C A U T I O N

Disconnect power before cleaning or maintenance.

CLEANING

Frequent cleaning is recommended to insure proper function, optimized light output, and an extended life. The frequency of cleaning depends on the environment in which the fixture operates: damp, smoky or particularly dirty environments can cause greater accumulation of dirt on the fixture's optics.

- Clean the external lens surface at least every 20 days with a soft cloth to avoid dirt/debris accumulation. NEVER use alcohol, solvents, or ammonia based cleaners.

MAINTENANCE

Regular inspections are recommended to insure proper function and extended life. There are no user serviceable parts inside this fixture, please refer all other service issues to an authorized Elation service technician. Should you need any spare parts, please order genuine parts from your local Elation dealer.

Please refer to the following points during routine inspections:

- A detailed electric check by an approved electrical engineer every three months, to make sure the circuit contacts are in good condition and prevent overheating.
- Be sure all screws and fasteners are securely tightened at all times. Loose screws may fall out during normal operation resulting in damage or injury as larger parts could fall.
- Check for any deformations on the housing, color lenses, rigging hardware and rigging points (ceiling, suspension, trussing). Deformations in the housing could allow for dust to enter into the fixture. Damaged rigging points or unsecured rigging could cause the fixture to fall and seriously injure a person(s).
- Electric power supply cables must not show any damage, material fatigue or sediments. Never remove the ground prong from the power cable.

TECHNICAL SPECIFICATIONS

SOURCE

(12) 12W 6-in-1 RGBAW+UV LEDs

100,000 Hour Average LED Life*

*May vary depending on several factors including but not limited to: Environmental Conditions, Power/Voltage, Usage Patterns (On-Off Cycling), Control, and Dimming.

EFFECTS

Pixel Control

Strobe and Chase Effects

Selectable Dimming Curves

COLOR

RGBAW+UV

CONTROL / CONNECTIONS

(8) DMX Channel Modes (79 total channels)

RDM (Remote Device Management)

4 Touch Button Control Panel and LCD Menu Display

5pin IP DMX In/Out

Power In/Out

SIZE / WEIGHT

Length: 33.9" (860mm)

Width: 5.6" (142mm)

Vertical Height: 4.9" (125mm)

Weight: 19.0 lbs. (8.6 kg)

ELECTRICAL / THERMAL

AC 100-240V - 50/60Hz

145W Max Power Consumption

5F to 113°F (-15°C to 45°C)

UV Wavelength: 395nm

APPROVALS / RATINGS

CE | RoHs | IP65**

**Optional Corrosion-Resistant Coating may be available for this fixture. Please consult an Elation sales representative for details.

Please Note: Specifications and improvements in the design of this unit and this manual are subject to change without any prior written notice.



PHOTOMETRIC DATA

	1 m	3.3 ft	2 m	6.6 ft	3 m	9.8 ft	4 m	13.1 ft	5 m	16.4 ft
25° Beam Diameter	0.45	1.5	0.88	2.9	1.33	4.4	1.77	5.8	2.21	7.3
	lux	fc	lux	fc	lux	fc	lux	fc	lux	fc
RED LEDs	1,253	116	542	50	283	26	172	16	119	11
GREEN LEDs	3,267	304	1,416	132	726	67	429	40	275	26
BLUE LEDs	469	44	211	20	108	10	65	6	45	4
WHITE LEDs	2,813	261	1,216	113	621	58	372	35	242	22
AMBER LEDs	1,286	119	532	49	271	25	153	14	101	9
UV LEDs	50	5	24	2	13	1	10	1	7	1
FULL ON	7,149	664	2,910	270	1,481	138	880	82	603	56

PHOTOMETRIC DATA (with DIFFUSION FILTER)

DIFFUSION FILTER

	1 m	3.3 ft	2 m	6.6 ft	3 m	9.8 ft	4 m	13.1 ft	5 m	16.4 ft
35° Beam Diameter	0.63	2.1	1.27	4.2	1.9	6.2	2.52	8.3	3.16	10.4
	lux	fc	lux	fc	lux	fc	lux	fc	lux	fc
RED LEDs	1,157	107	503	47	260	24	161	15	109	10
GREEN LEDs	2,492	232	1,041	97	528	49	316	29	211	20
BLUE LEDs	477	44	202	19	103	10	65	6	45	4
WHITE LEDs	2,701	251	1,135	105	576	54	346	32	231	21
AMBER LEDs	1,199	111	510	47	259	24	155	14	104	10
UV LEDs	75	7	36	3	22	2	16	1	13	1
FULL ON	6,413	596	2,608	242	1,287	120	767	71	508	47

PHOTOMETRIC DATA (with FROST FILTER)

FROST FILTER

	1 m	3.3 ft	2 m	6.6 ft	3 m	9.8 ft	4 m	13.1 ft	5 m	16.4 ft
45° Beam Diameter	0.83	2.7	1.66	5.4	2.49	8.2	3.31	10.9	4.14	13.6
	lux	fc	lux	fc	lux	fc	lux	fc	lux	fc
RED LEDs	689	64	258	24	127	12	79	7	52	5
GREEN LEDs	2,015	187	722	67	358	33	222	21	147	14
BLUE LEDs	358	33	126	12	66	6	41	4	28	3
WHITE LEDs	1,809	168	631	59	313	29	196	18	129	12
AMBER LEDs	858	80	314	29	150	14	98	9	65	6
UV LEDs	47	4	21	2	12	1	8	1	7	1
FULL ON	4,377	407	1,563	145	760	71	465	43	307	29

Please Note: Specifications and improvements in the design of this unit and this manual are subject to change without any prior written notice.

DIMENSIONAL DRAWINGS

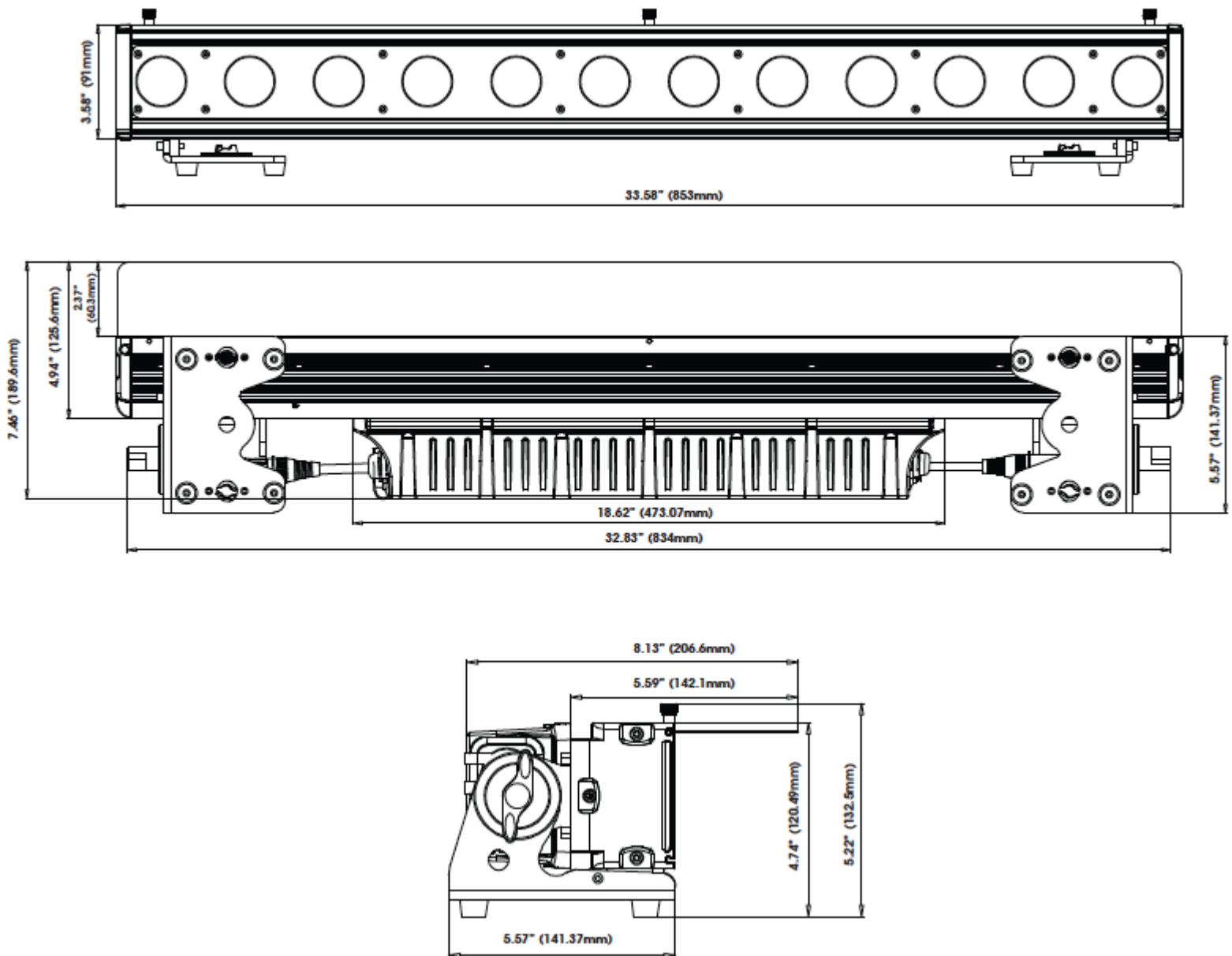

Please Note: Specifications and improvements in the design of this unit and this manual are subject to change without any prior written notice.

OPTIONAL ACCESSORIES

ORDER CODE	ITEM
TRIGGER CLAMP	Heavy Duty Wrap Around Hook Style Clamp
EWD001	EWDMX IP Wireless IP65 DMX Transceiver
8050000053	Omega Bracket (single)
NEU088	Power Link Cable
	Additional Cable Lengths Available

